

Date		Notes
Project		
Type	Qty	

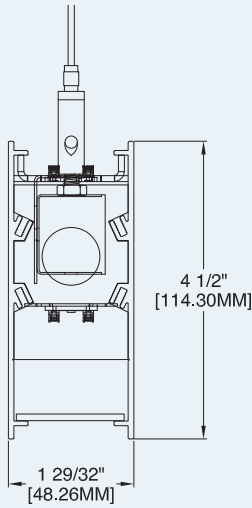

Direct
Indirect

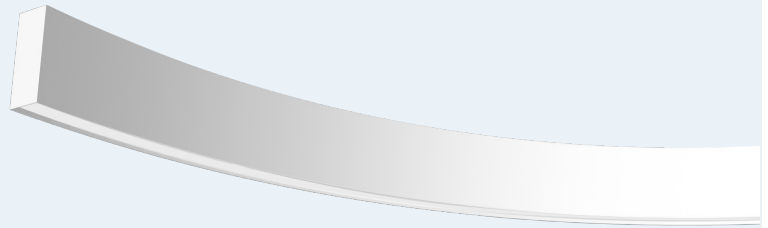

Features

- Custom-rolled aluminum housing w/welded end-plates.
- LED optimized optics for smooth, non-pixelated illumination end-to-end.
- Suspension mount for individual fixtures, continuous runs or custom patterns.
- High efficiency programmable driver for custom lumen packages. 0-10V dimming to 1% standard.
- High efficacy LEDs in 80 or 90 CRI; two or three channel tunable white; five channel tunable color.

Ordering Guide

MODEL	OPTICS	CCT	LUMENS ¹	SIZE ²	MOUNTING ³	FINISH	OPTIONS ⁴
ARCL-14-DI	DP						
ARCL-14-DI Direct/Indirect	DP = Diffuse Polycarbonate w/clear acrylic dust covers. (lay-in)	27 = 2700K 80CRI 30 = 3000K 80CRI 35 = 3500K 80CRI 40 = 4000K 80CRI 50 = 5000K 80CRI For 90CRI add "9" prefix. Ex: 940 = 4000K @ 90 CRI	LO = 1090/ft (10W/ft, 106LPW) SO = 1460/ft (14W/ft, 104LPW) HO = 1825/ft (18W/ft, 101LPW) Consult factory for additional lumen packages. All values nominal.	Arc is a 100% custom product. See page 2 for instructions for creating SIZE ordering code and for custom patterns.	AC = Aircraft Cable PD = Pendant Stem	W = White CC = Custom Color AMW = Anti-Microbial White	DIMMING DRIVERS DIM10 = 0-10V (1%) - Standard DIMSR = 0-10V (5.0%) Sensor Ready DIMST = Step Dimming (40%/100%) DALI = DALI (5.0%) LUTRON™ DIMMING DRIVERS LDE1 = Hi-Lume™ 1% EcoSystem™ LDE5 = 5-Series 5% EcoSystem™ L3DA3W = Hi-Lume™ 1% 3-Wire LTEA2W = Hi-Lume 1% 2-Wire 120V SENSORS & CONTROLS ESN = Philips™ EasySense DAY = Daylight Harvesting OCC = Occupancy Sensor EMERGENCY EMC = Emergency Circuit GTD = Generator Transfer Device EPC4 = 4W Emergency Battery Pack EPC7 = 7W Emergency Battery Pack EPC10 = 10W Emergency Battery Pack EPC12 = 12W Emergency Battery Pack OTHER TCW = Two Circuit Wiring Some options limited by ARCL-14 radius and components size. Consult factory.

¹Delivered Lumens at 80+CRI 4000K CCT. Use the following multiplier to estimate delivered lumens at other CCTs: 2700K = 0.94, 3000K = 0.96, 3500K = 0.98, 5000K = 1.02. All values nominal. See page 3 for photometry.

²See page 2 for specifying custom radii.

³See page 3 for suspension details.

⁴Consult factory for EPC location. Some options remote mount only.



Configuring Size Code

Arc may be ordered in virtually any radius and length and is easy to specify. Simply use order code "XRL" where XR = Radius, and L = Length in feet. Day-O-Lite will design length to closest LED module length and provide drawings for approval.

Examples:

- 30' radius, 20' length = 30R20
- 10' radius, 12' length = 10R12
- 6' radius, 4' length = 6R4

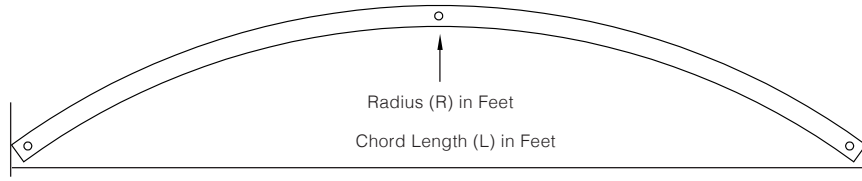

Pattern Guide

Arc may be specified in patterns of virtually any configuration. All patterns and radii are continuously illuminated and joined with included aligner brackets and joining hardware. See examples below for pattern suggestions. All Arc connectors and housings are fully welded to ensure correct dimensions without light leaks when assembled.

How to Specify

1. Submit your pattern to Day-O-Lite in dimensioned CAD file or submit a fully dimensioned PDF file.
2. If EPC/EMC or Sensors are to be included their location needs to be clearly noted.
3. Day-O-Lite will design your pattern to as close as is nominally possible given standard LED module lengths, including connectors.
4. Day-O-Lite will supply a detailed drawing for approval with final dimensions. All patterns must be approved prior to manufacture.

Pattern Examples

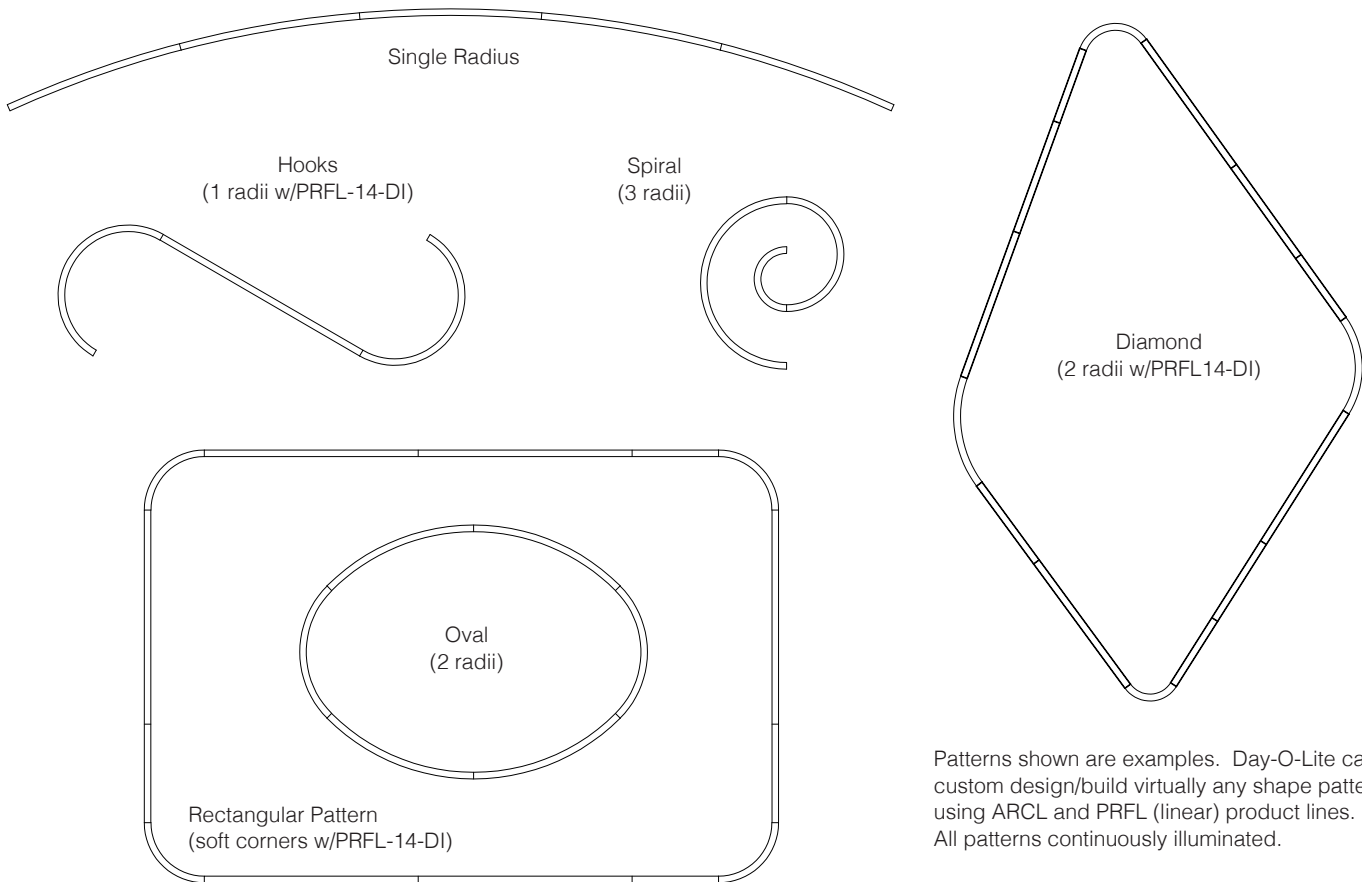

Patterns shown are examples. Day-O-Lite can custom design/build virtually any shape pattern using ARCL and PRFL (linear) product lines. All patterns continuously illuminated.

Standard Suspensions

Standard suspension options include adjustable self-locking aircraft cables (AC) and rigid pendant stems (PD). AC assembly is 48" x 1/16" with a 5" feed canopy and 2" suspension canopies. 60" 18 gauge power and 22 gauge dimming control SJT feed.

PD assemblies are 5/8" dia. (or 3/8" IP) hollow stem for power feed by others, 24" is standard. Consult factory for longer suspension lengths and other mounting options.

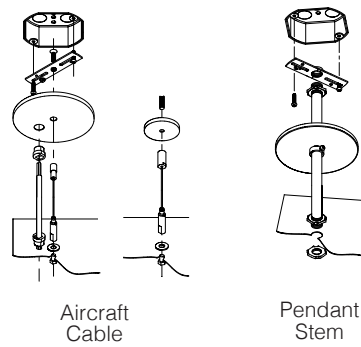

Photometry

ARCL-14-DI-DP-40-LO-4

ARCL-14-DI-DP-40-SO-4

ARCL-14-DI-DP-40-HO-4

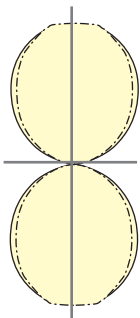

4000K CCT
WATTS: 40
LUMENS: 4360
LPW: 104
Distribution:
47% Direct
53% Indirect

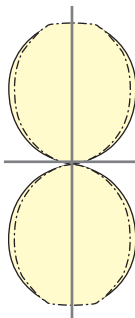

4000K CCT
WATTS: 56
LUMENS: 5840
LPW: 104
Distribution:
47% Direct
53% Indirect

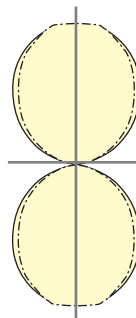

4000K CCT
WATTS: 72
LUMENS: 7300
LPW: 101
Distribution:
47% Direct
53% Indirect

Specifications

CONSTRUCTION Extruded aluminum housing. 20 gauge cold rolled steel internal components.

REFLECTOR Die-formed steel finished in highly reflective baked white enamel with pre-finished reflective LED tray.

OPTICS LED optimized Diffuse Polycarbonate (DP) lens is standard, w/clear acrylic dust covers (CA).

LED Modules in 30/35/40 & 50K CCT, 80/90CRI. Lumen maintenance minimum $L_{70} = 50,000$ hours. 3 SDCM; field replaceable.

DRIVER Standard driver is Class 2 AOC 0-10V to 1%, 120/277V input, PF > 90%, THD < 20 @ 120V. Additional dimming protocols available. All drivers prewired from factory for connection to control system (by others); field replaceable.

MOUNTING Standard options include adjustable self-locking aircraft cables (AC), and rigid pendant stems (PD). AC assembly is 48" x 1/16" with a 5" feed canopy and 2" suspension canopies. 18 gauge power and 22 gauge dimming control SJT feed.

FINISH Housing and components finished in baked white enamel. Canopies and pendant stems are white enamel unless otherwise specified.

CERTIFICATION Luminaires are cETLus listed conforming to UL STD. 1598 and certified to CSA STD C22.2 NO. 250.0. Suitable for dry & damp locations. Union Made in the United States of America. I.B.E.W. RoHS compliant.