

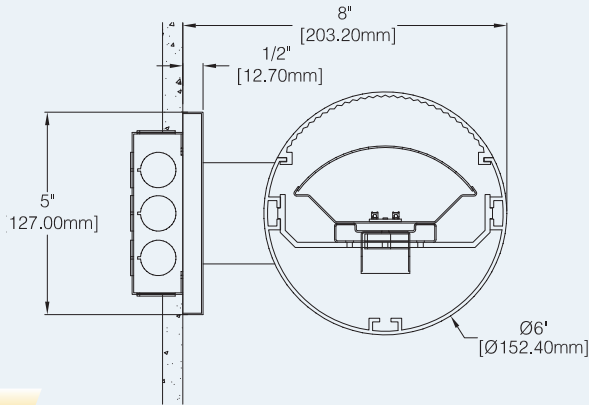

Round Series | ADL-RO6-I-WM

Date		Notes
Project		
Type	Qty	

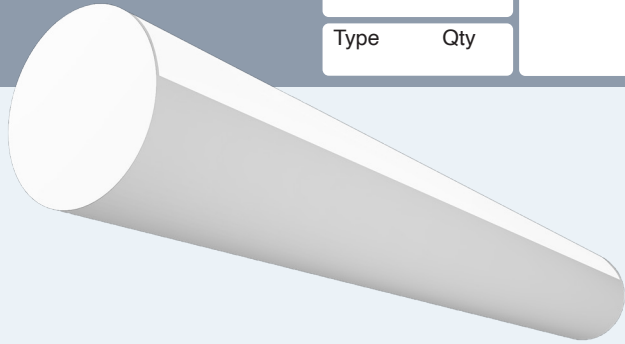

Features

- Extruded aluminum housing w/welded end-plates.
- LED optimized optics for smooth illumination end-to-end.
- Wall mount for individual fixtures, continuous runs or custom patterns.
- High efficiency programmable driver for custom lumen packages. 0-10V dimming to 1% standard.
- High efficacy LEDs in 80 or 90 CRI; two or three channel tunable white; five channel tunable color.

Ordering Guide

MODEL	OPTICS	CCT ¹	LUMENS ²	LENGTH ³	MOUNTING ⁴	FINISH	OPTIONS
ADL-RO6-I	WRA				WM		
ADL-RO6-I Indirect	WRA = White Acrylic Ribbed Lens	27 = 2700K 80CRI 30 = 3000K 80CRI 35 = 3500K 80CRI 40 = 4000K 80CRI 50 = 5000K 80CRI 90 CRI add *9' Ex: 940 = 4000K @ 90 CRI	LO = 615/ft (5W/ft, 119LPW) SO = 820/ft (7W/ft, 117LPW) HO = 1025/ft (9W/ft, 114LPW) Consult factory for additional lumen packages. All values nominal	4 = 4 ft 6 = 6 ft 8 = 8 ft For other enter row length (e.g. 48 = 48 ft)	WM = Wall Mount	W = White CC = Custom Color AMW = Anti-Microbial White	DIMMING DRIVERS DIM10 = 0-10V (1.0%) - Standard DIMSR = 0-10V (5.0%) Sensor Ready DIMST = Step Dimming (40%/100%) DALI = DALI (5.0%) LUTRON™ DIMMING DRIVERS LDE1 = Hi-Lume™ 1% EcoSystem™ LDE5 = 5-Series 5% EcoSystem™ L3DA3W = Hi-Lume™ 1% 3-Wire LTEA2W = Hi-Lume 1% 2-Wire 120V SENSORS & CONTROLS ESN = Philips™ EasySense DAY = Daylight Harvesting OCC = Occupancy Sensor CAS = Casambi Bluetooth control VDO = Vive Sensor by Lutron EMERGENCY EMC = Emergency Circuit GTD = Generator Transfer Device EPC4 = 4W Emergency Battery Pack EPC7 = 7W Emergency Battery Pack EPC10 = 10W Emergency Battery Pack EPC12 = 12W Emergency Battery Pack
	TUNABLE WHITE & COLOR¹						
	<u>2-Channel White</u> 2DIM10 = for 0-10V 2DALI = for DALI 2DMX = for DMX 2PSQ = for Lutron 2SNS = for Signify 2CAS = for Casambi <u>3-Channel White</u> 3DML = for DLM <u>3-Channel Color</u> RGB <u>4-Channel Color/White</u> RGBW <u>5-Channel Color/Warm White/Cool White</u> RGBWW						

¹Tunable white, tunable color and RGB/W options detailed on page 4.

²Delivered Lumens are Standard Output (SO) and Low Output (LO) at 80+CRI 4000K CCT. Use the following multiplier to estimate delivered lumens at other CCTs: 2700K = 0.94, 3000K = 0.96, 3500K = 0.98, 5000K = 1.02. All values nominal. See page 3 for photometry.

³See page 2 for actual fixture lengths and mounting locations.

⁴See page 3 for mounting details.



Individual Fixtures & Continuous Rows

NOMINAL LENGTH	ACTUAL LENGTH	WALL BRKTS.	WALL O.C. 1	WALL O.C. 2	WALL O.C. 3+
4'	4' 1/4"	2	38"		
8'	8' 1/4"	2	48"		
12'	12' 1/4"	3	48"	48"	
16'	16' 1/4"	4	48"	48"	48"
20'	20' 1/4"	5	48"	48"	48"
24'	24' 1/4"	6	48"	48"	48"

Individual fixtures and rows are continuously illuminated and joined with included aligner brackets and hardware. Lengths and mounting locations are shown below.

Individual fixtures up to 8' nominal and continuous rows up to 24' nominal are dimensioned as shown below. Continuous rows longer than 8' and patterns, including EPC/EMC and sensor locations must be approved prior to manufacturing.

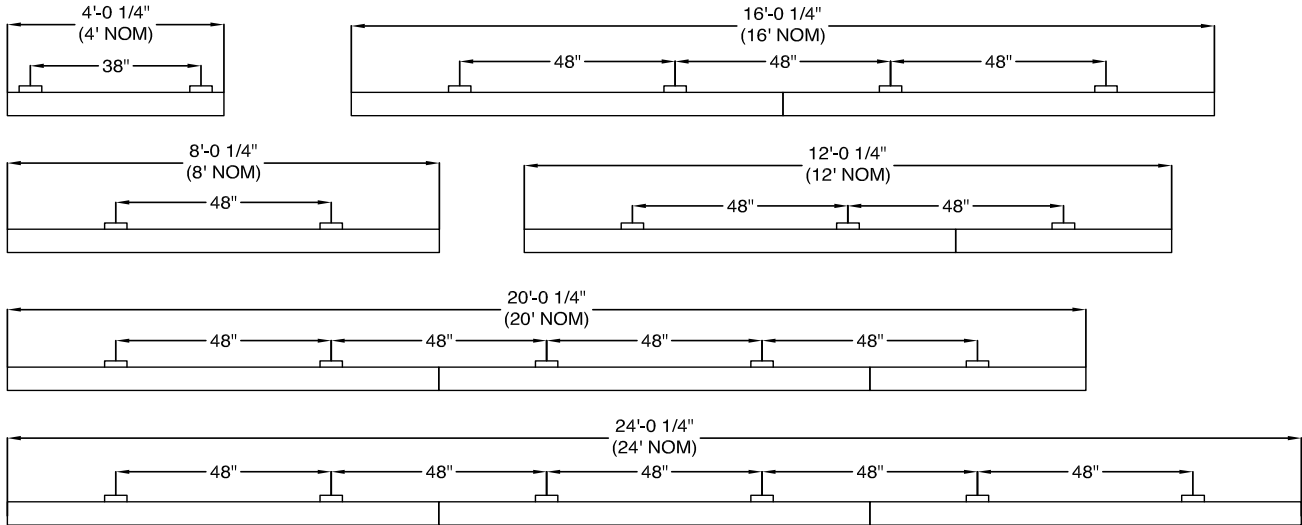

Emergency & Sensor Locations

EPC will control entire length of individual fixtures. Individual fixtures of differing lengths will deliver the same lumens under EPC power (a 4' fixture will deliver the same total lumens over half the length of an 8' fixture). EMC controlled individual fixtures will deliver lumens per foot as originally specified, unless dimmed at time of power loss. Consult factory for EMC dimming override device.



For individual fixtures to 8' EPC/EMC will power entire fixture.



For continuous rows longer than 8' one EPC/EMC will be located in the feed section (end-left) of the row as shown below.

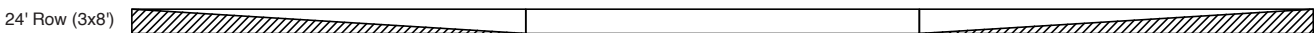

If two EPC/EMC's are required their default locations will be in the feed section (end-left) and last section (end-right) as below.



Custom placement of one or more EPC/EMC's must be clearly identified during ordering.



SENSORS (Integral) for individual fixtures will control entire length of fixture and will be located on feed end of fixture.

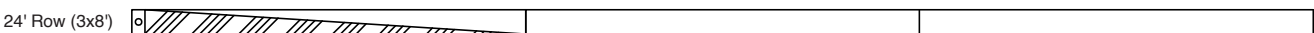

SENSORS for rows by default will control the feed section (end-left) of the row. Sensors can control more than an 8' section within a row. Consult factory for sensor/section options, or for multiple sensors in a continuous row.

Photometry

ADL-RO6-I-WRA-40-LO-4

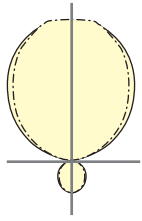

4000K CCT
WATTS: 21
LUMENS: 2464
LPW: 117
Distribution:
92% Indirect
8% Direct

ADL-RO6-I-WRA-40-SO-4

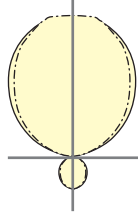

4000K CCT
WATTS: 28
LUMENS: 3285
LPW: 117
Distribution:
92% Indirect
8% Direct

Wall Bracket Detail

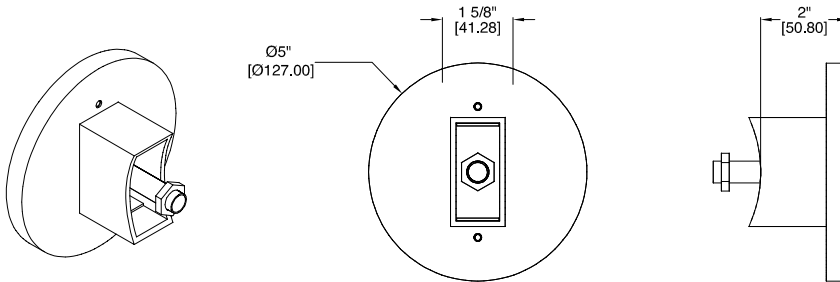

Specifications

HOUSING: Extruded aluminum housing. Finished end caps are welded with no exposed hardware or knockouts.

REFLECTOR: Die-formed steel finished in highly reflective baked white enamel.

OPTICS: LED optimized white acrylic ribbed lens (WRA) is standard.

LEDS: LED modules in 30/35/40 & 50K CCT, 80 CRI (90CRI available). Lumen maintenance minimum L_{70} = 50,000 hours. 3 SDCM color consistency. Zhaga™ compliant (Book 7). Field replaceable.

DRIVER Standard driver is Class 2 AOC 0-10V to 1%, 120/277V input, PF > 90%, THD < 20 @ 120V. Additional dimming protocols available. All drivers prewired from factory for connection to control system (by others). Field replaceable.

MOUNTING: Standard installation is wall mount with included mounting brackets and hardware. Requires single-gang j-box supplied by others.

FINISH: Aluminum fixture housing and steel components are finished in baked white enamel applied over a five-stage pretreatment process. Canopies and pendant stems are white enamel unless otherwise specified.

CERTIFICATION: Luminaires are cETLus listed conforming to UL STD. 1598 and certified to CSA STD C22.2 NO. 250.0. Suitable for dry & damp locations. Union Made in the United States of America. I.B.E.W. RoHS compliant.

Day-O-Lite offers a variety of tunable white and tunable color options for a range of human centric applications and budgets. It is recommended that a recognized authority on the benefits and best practices of tunable white be consulted prior to specification. As a rule, fewer channels will provide a basic level of performance for budget conscious applications. Conversely, an increased number of channels, a wider CCT range, higher CRI and more precise color consistency may be more appropriate depending on the application and desired results.

HOW TO SPECIFY

Select from the various channel/control options below and insert desired **Ordering Code** into the **COLOR TEMP** column of the Ordering Guide on page 1. No need to add a dimming option as the codes include the chosen protocol.

2-CHANNEL TUNABLE WHITE OPTIONS

2700K - 6500K CCT range
1000L/ft LED modules @ 4000K
80+ CRI w/3SDCM color accuracy
10W/ft. nominal power

Ordering Codes

2DIM10 for 0-10V control
2DALI for DALI control
2DMX for DMX control
2PSQ for Lutron Quantum control
2SNS for control via Signify SNS sensors
2CAS for control via Casambi BLE wireless devices

LEGRAND BLANCO MULTI-CHANNEL OPTIONS

Blanco-2

Blanco-2 mixes two channels of white LEDs to approximate the blackbody curve for tunable white applications. CCT and intensity may be adjusted with controls by others.

3000K-5000K CCT range
1000L/ft LED modules @ 4000K
90+ CRI w/2SDCM color accuracy
10W/ft. nominal power

Ordering Codes

B2DLM for DLM control

Blanco-3

Blanco-3 mixes three channels of white LEDs across a wider range of color temperatures for more demanding tunable white applications. CCT and intensity may be adjusted with controls by others.

2700K-6500K CCT range
1000L/ft. LED modules @ 4000K
90+ CRI w/SDCM color accuracy
10W/ft. nominal power

Ordering Codes

B3DLM for DLM control

RGB & RGBW TUNABLE COLOR

RGB = Red, Green, Blue color mixing LEDs
RGB/W = Red, Green, Blue + White of chosen CCT
Dimming from 100% to 1%.
90+ CRI w/3SDCM color accuracy
10W/ft. nominal power

Notes:

RGB requires an RGB DMX or DALI controller (by others)

RGBW requires an RGBW DMX or DALI controller (by others)

All channels on one driver is standard, if isolating the White from the RGB channels is desired please consult factory.

RGB and RGBW are not recommended for tunable white applications.

Ordering Codes

RGB for DMX control
RGB27 for DMX control w/2700K white
RGB30 for DMX control w/3000K white
RGB35 for DMX control w/3500K white
RGB40 for DMX control w/4000K white
RGB50 for DMX control w/5000K white
RGB65 for DMX control w/6500K white
Add Suffix **DAL** for DALI Control to codes above.

5-CHANNEL TUNABLE WHITE AND COLOR

RGBWW = Red, Green, Blue, Warm White, Cool White.
Consult factory for RGBWW tunable white/color options.

Day-O-Lite makes no claims as to the psychological or physiological efficacy of the white color tuning options offered herein.