

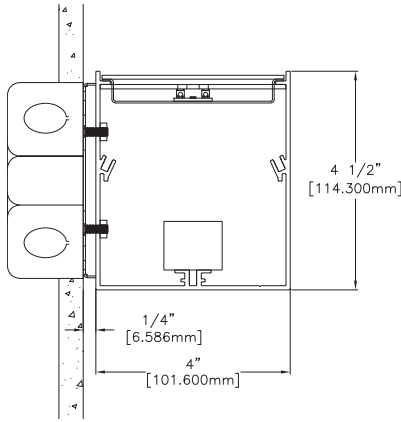

Profile Series | PRFL-44-I-WM

Date		Notes
Project		
Type	Qty	



Clear Acrylic (CA) shown.
See page 3 for other lens details.

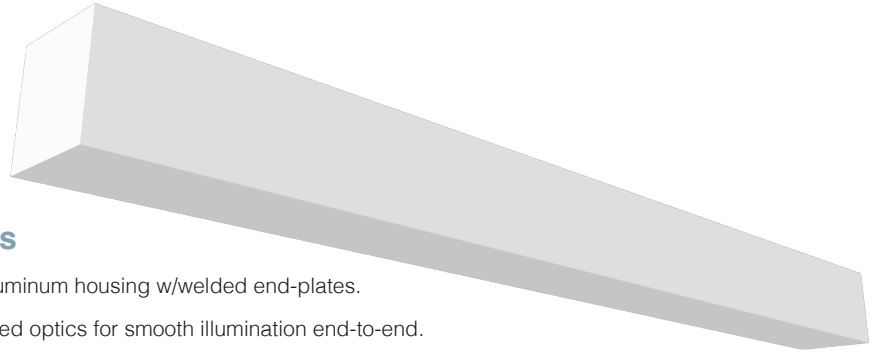

Features

- Extruded aluminum housing w/welded end-plates.
- LED optimized optics for smooth illumination end-to-end.
- Suspension mount for individual fixtures, continuous runs or custom patterns.
- High efficiency programmable driver for custom lumen packages. 0-10V dimming to 1% standard.
- High efficacy LEDs in 80 or 90 CRI; tunable white and tunable color.
- BIOS SkyBlue™ circadian technology available.
- A Declare Red List Approved product.



Note DLC options at bottom of page.

Ordering Guide

MODEL	OPTICS	CCT	LUMENS ⁴	LENGTH ⁵	MOUNTING	FINISH	OPTIONS
PRFL-44-I					WM		
Profile 44 Indirect	CA = Clear Acrylic Dust Covers (lay-in) Standard FL = Flush Opal Acrylic (snap-in) SI = Satin Ice Acrylic (lay-in) AS = Asymmetric (lay-in) CM = Collimating (lay-in) BW = Bat Wing (lay-in)	STATIC WHITE¹ 27 = 2700K 30 = 3000K 35 = 3500K 40 = 4000K 50 = 5000K BIOS SkyBlue² Spectrally optimized circadian solutions. TUNABLE WHITE³ (2700K-6500K) 2DIM10 = for 0-10V 2DMX = for DMX 2PSQ = for Lutron 2SNS = for Signify 2CAS = for Casambi RGB + WHITE³ RGB = RGB RGBW = RGBW	LO = 650/ft (4.5W/ft, 145LPW) SO = 870/ft (6W/ft, 145LPW) HO = 1088/ft (7.5W/ft, 145LPW) DLC V5.1⁴ SO = 885/ft (5.75W/ft, 154LPW) Consult factory for custom lumen packages. All values nominal.	2 = 2 ft 3 = 3 ft 4 = 4 ft 5 = 5 ft 6 = 6 ft 7 = 7 ft 8 = 8 ft For other enter row length (e.g. 48 = 48 ft)	WM = Wall Mount	W = White CC = Custom Color AMW = Anti-Microbial White	DIMMING DRIVERS DIM10 = 0-10V (1%) - Standard DIMSR = 0-10V (5.0%) Sensor Ready DIMST = Step Dimming (40%/100%) DALI = DALI (5.0%) LUTRON™ DIMMING DRIVERS LDE1 = Hi-Lume™ 1% EcoSystem™ L3DA3W = Hi-Lume™ 1% 3-Wire SENSORS & CONTROLS ESN = Philips™ EasySense DAY = Daylight Harvesting OCC = Occupancy Sensor CAS = Casambi Bluetooth control VDO = Vive Sensor by Lutron AWNR = Athena RF/Node AWNS = Athena Wireless Sensor EMERGENCY EMC = Emergency Circuit GTD = Generator Transfer Device EPC4 = 4W Emergency Battery Pack EPC7 = 7W Emergency Battery Pack EPC10 = 10W Emergency Battery Pack EPC12 = 12W Emergency Battery Pack

¹CCT @ 80+CRI, 3SDCM. For 90CRI add prefix '9'; ex: 935 = 3500K, 90CRI.

²BIOS Skyblue Biological Static & Dynamic page 3.

³Tunable White, RGB and RGB+White ordering codes page 2.

⁴**DLC** options are limited to CA optics, static white 35/40K CCT @ 80CRI, SO lumens, all mounting, all finishes, and all options excluding DIMST.

⁵See page 4 for actual fixture lengths and mounting locations.



TUNABLE WHITE - Fixture Level Control



Day-O-Lite offers Tunable White in a range from 2700K-6500K CCT @ 80+CRI and 3SDCM color accuracy for a range of two-channel control options. Consult factory for 90CRI, electrical specifications and other details for each option below.

2SNS Option combines tunable white light with a fixture integrated occupancy and daylight harvesting sensor. CCT and intensity is controlled wirelessly with kinetic switches (by Illumra and others). Occupancy and daylight harvesting controlled automatically with parameters configurable with the Philips MasterConnect app available for Android and iPhone smart phones.

Applications:

- Spaces occupied overnight (~ 7pm to 7am)
- 24-hour spaces
- Shiftwork & Hospitals
- Senior Living, Alzheimer's Dementia & Assisted Living
- Higher Education, including student and staff
- Workplace, including areas occupied after 7pm

Ordering Codes:

- 2DIM10** = 0-10V
- 2DMX** = DMX
- 2PSQ** = Lutron Quantum
- 2CAS** = Casambi Wireless
- 2ESN** = Philips EasySense Sensor
- 2AWN** = Lutron Athena RF only
- 2AWNS** = Lutron Athena RF/Sensor

RGB + WHITE - Fixture Level Control



Combine RGB for color effects with LO/SO/HO white CCT's for general illumination in a host of applications. All options require DMX control (by others). 80CRI w/3SDCM color accuracy is standard. Consult factory for 90CRI, electrical specifications and other details for each option below. May not be compatible with all variations of PRFL-44 -consult factory for details when ordering.

Applications:

- Entertainment Spaces
- Hospitality & Banquet
- Theatre & Stage
- Seasonal Applications
- Branding
- Wayfinding

Ordering Codes:

- RGB** = RGB only
- RGB27** = RGB w/2700K
- RGB30** = RGB w/3000K
- RGB35** = RGB W/3500K
- RGB40** = RGB w/4000K
- RGB50** = RGB w/5000K

Photometry

PRFL-44-I-CA-40-SO-4
Clear Dust Cover (CA)

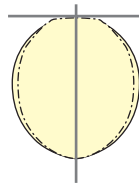

4000K CCT
WATTS: 23
LUMENS: 3540
LPW: 154
Distribution:
100% Indirect
DLC V5.1 Listed

PRFL-44-I-SI-40-SO-4
Satin Ice Lens (SI)

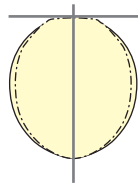

4000K CCT
WATTS: 23
LUMENS: 3345
LPW: 145
Distribution:
100% Indirect

PRFL-44-I-FL-40-SO-4
Flush Lens (FL)

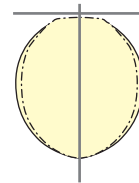

4000K CCT
WATTS: 23
LUMENS: 3086
LPW: 140
Distribution:
100% Indirect

BIOS SkyBlue

BIOS SkyBlue biological technology brings the benefits of blue skies inside. BIOS SkyBlue is the only spectrally optimized circadian solution to pinpoint the region that drives wellness benefits including: increased alertness, enhanced productivity, better mood, and better sleep. More information may be found at www.bioslighting.com or by contacting Day-O-Lite directly.

BIOS Biological Static - Daytime Solution

BIOS Biological Static solutions are designed for daytime applications. BIOS Static Biological LED features key BIOS SkyBlue™ (490nm) for maximum daytime circadian impact. BIOS Static Biological LED Light Engines are available in 3000K, 3500K, and 4000K. Lighting controls are easy; simply switch the lights on/off or the lights can be dimmed using a single-channel constant current (CC) LED driver with any standard dimming interface.

Applications:

- Spaces occupied during the daytime ~7am – 7pm
- K-12 Schools / Higher Education
- Offices
- Daytime Adult Care Facilities
- Medical Offices

BIOS Biological Static
Ordering Codes:

- B30** = 3000K
- B35** = 3500K
- B40** = 4000K

BIOS Biological Static 3500K

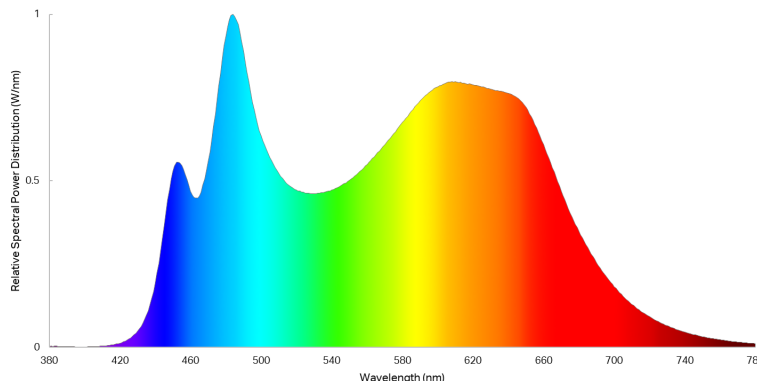

BIOS Biological Dynamic - Day & Night Solution A

BIOS Biological Dynamic solutions are designed to transition from daytime to evening in a dim-to-warm protocol. The daytime CCT includes full BIOS SkyBlue™ (490nm) for maximum daytime circadian impact, while the evening spectrum removes BIOS SkyBlue™ altogether, providing a minimal circadian stimulus after hours. Available in 3000K-2700K, 3500K-3000K and 4000K-3500K. Simply dim the lights in the evening to remove the daytime SkyBlue wavelengths (490nm) and convert your lights from day mode to night mode via a single controller (0-10V, ELV, DMX, Wireless).

BIOS Biological Tunable White - Day & Night Solution B

BIOS Biological Tunable solutions are designed to transition from daytime to evening in a dim-to-warm protocol. The daytime CCT includes full BIOS SkyBlue™ (490nm) for maximum daytime circadian impact, while the evening spectrum removes BIOS SkyBlue™ altogether, providing a minimal circadian stimulus after hours. Available in 3000K-2700K, 3500K-3000K and 4000K-3500K. Simply dim the lights in the evening to remove the daytime SkyBlue wavelengths (490nm) and convert your lights from day mode to night mode via a single controller (0-10V, ELV, DMX, Wireless).

BIOS Biological Tunable is also compatible with two-channel color tuning systems. Simply dim the lights in the evening to convert your lights from day mode to night mode via a multi-channel controller (0-10V, ELV, DMX, Wireless). 3000K, 3500K and 4000K CCTs all dim to 2700K.

Applications:

- Spaces occupied overnight (~ 7pm to 7am)
- 24-hour spaces
- Shiftwork & Hospitals
- Senior Living, Alzheimer’s Dementia & Assisted Living
- Higher Education, including student and staff
- Workplace, including areas occupied after 7pm

BIOS Biological
Dynamic White
Ordering Codes:

- B30D** = 3000K-2700K
- B35D** = 3500K-3000K
- B40D** = 4000K-3500K

BIOS Biological
Tunable White
Ordering Codes:

- B30T** = 3000K-2700K
- B35T** = 3500K-2700K
- B40T** = 4000K-2700K

BIOS Biological Dynamic 3500K

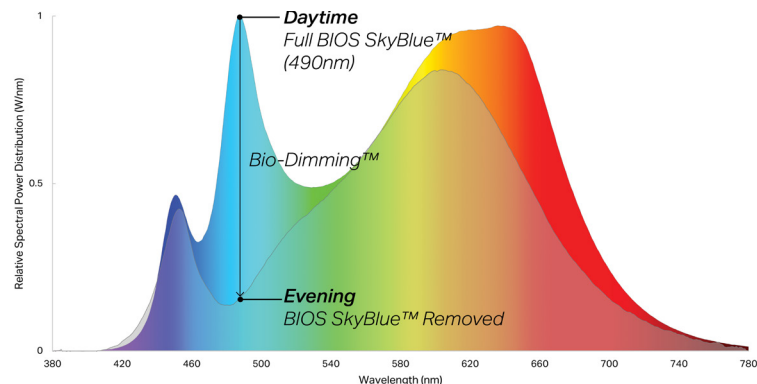

Individual Fixtures & Continuous Rows

NOMINAL LENGTH	ACTUAL LENGTH	WALL BRKTS.	WALL O.C. 1	WALL O.C. 2	WALL O.C. 3
4'	48"	2	46"		
6'	72"	2	70"		
8'	96"	2	94"		
12'	144"	3	94"	48"	
16'	192"	3	94"	96"	48"
20'	240"	4	94"	96"	48"
24'	288"	4	94"	96"	96"

Individual fixtures and rows are continuously illuminated and joined with included aligner brackets and hardware. Power feed locations and mounting locations are shown below.

Continuous rows longer than 8' and patterns, including EPC/EMC and sensor locations must be approved prior to manufacturing.

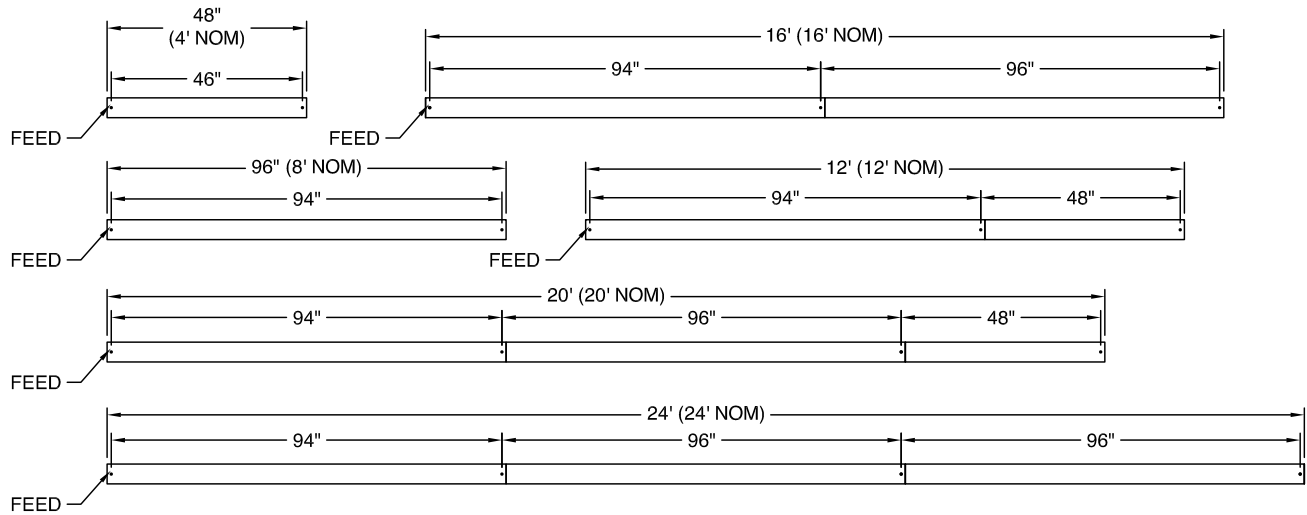

Emergency & Sensor Locations

EPC will control entire length of individual fixtures. Individual fixtures of differing lengths will deliver the same lumens under EPC power (a 4' fixture will deliver the same total lumens over half the length of an 8' fixture). EMC controlled individual fixtures will deliver lumens per foot as originally specified, unless dimmed at time of power loss. Consult factory for EMC dimming override device.



For individual fixtures to 8' EPC/EMC will power entire fixture.

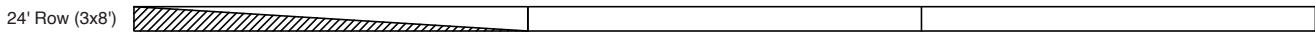

For continuous rows longer than 8' one EPC/EMC will be located in the feed section (end-left) of the row as shown below.

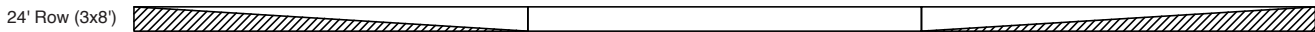

If two EPC/EMC's are required their default locations will be in the feed section (end-left) and last section (end-right) as below.



Custom placement of one or more EPC/EMC's must be clearly identified during ordering.



SENSORS (Integral) for individual fixtures will control entire length of fixture and will be located on feed end of fixture.

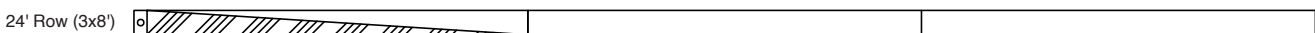

SENSORS for rows by default will control the feed section (end-left) of the row. Sensors can control more than an 8' section within a row. Consult factory for sensor/section options, or for multiple sensors in a continuous row.

Specifications

CONSTRUCTION Extruded aluminum housing. 20 gauge cold rolled steel internal components.

REFLECTOR Die-formed steel finished in highly reflective baked white enamel with pre-finished reflective LED tray.

OPTICS LED optimized (CA) Clear Acrylic standard, (FL) Flush Opal Acrylic, (PL) Pop Opal Acrylic, (SI) Satin Ice acrylic, (AS) Asymmetric, (CM) Collimating and (BW) Bat Wing lenses available.

LED Static white LED modules in 27/30/35/40 & 50K CCT, 80/90CRI. Lumen maintenance minimum L_{70} = 50,000 hours. 3 SDCM color consistency. BIOS SkyBlue, RGB, RGBW and Tunable White and Advanced Color options available.

DRIVER Standard driver is Class 2 AOC 0-10V to 1%, 120/277V input, PF > 90%, THD < 20 @ 120V. Additional dimming protocols available. All drivers prewired from factory for connection to control system (by others). Field replaceable.

MOUNTING: Installation is wall mount with included mounting brackets and hardware. Requires single-gang j-box supplied by others.

FINISH Housing and components finished in baked white enamel.

CERTIFICATION Luminaires are cETLus listed conforming to UL STD. 1598 and certified to CSA STD C22.2 NO. 250.0. Suitable for dry & damp locations. Union Made in the United States of America. I.B.E.W. RoHS compliant. DLC V5.1 listed.