

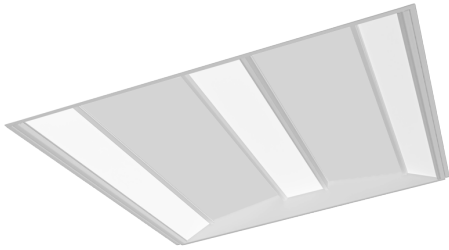

Medical | MEDL-TF 2x2 Exam/Ambient

Date		Notes
Project		
Type	Qty	



Exam Function
Up to 4760 lumens



Ambient Function
Up to 3080 lumens

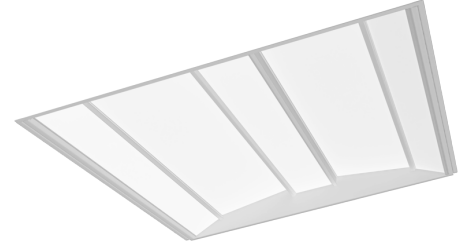

Exam/Ambient
Over 7800 lumens

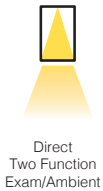

Features

- Multi-function medical fixture incorporating Exam and Ambient functions in both 2x2 and 2x4 configurations.
- Special LED optimized optics for maximum illumination in both functions; Anti-Microbial finish available.
- For installation in a wide variety of suspended grid and plaster/drywall ceilings including Armstrong ceilings.
- High efficiency driver for custom lumen packages. 0-10V dimming to 1% standard. Tunable White options available.

Ordering Guide

MODEL	OPTICS	CCT ¹	LUMENS ²	SIZE	MOUNTING ³	FINISH	OPTIONS
MEDL-TF	SA			22			
MEDL-TF Direct Two Function Exam/Ambient	SA = Satin Ice Acrylic (center lenses with Ribbed Acrylic (outside lenses))	27 = 2700K 80CRI 30 = 3000K 80CRI 35 = 3500K 80CRI 40 = 4000K 80CRI 50 = 5000K 80CRI 90 CRI add "9" Ex: 940 = 4000K @ 90 CRI	LO = Exam = 3570 Ambient = 2310 E/A = 5860 SO = Exam = 4760 Ambient = 3080 E/A = 7813 Consult factory for additional lumen packages. All values nominal.	22 = 2x2	G = Grid MG = Mini Grid SG = Slot Grid F = Flanged (recessed) S = Surface See all mounting options page 2.	W = White CC = Custom Color AMW = Anti-Microbial White AMW finish contains SilverSan™ ionic silver to inhibit the growth of bacteria.	DIMMING DRIVERS DIM10 = 0-10V (1.0%) - Standard DIMSR = 0-10V (5.0%) Sensor Ready DIMST = Step Dimming (40%/100%) DALI = DALI (5.0%) LUTRON™ DIMMING DRIVERS LDE1 = Hi-Lume™ 1% EcoSystem™ LDE5 = 5-Series 5% EcoSystem™ L3DA3W = Hi-Lume™ 1% 3-Wire LTEA2W = Hi-Lume 1% 2-Wire 120V SENSORS & CONTROLS ESN = Philips™ EasySense DAY = Daylight Harvesting OCC = Occupancy Sensor LVC = 2-Channel LV Controller EMERGENCY EPC4 = 4W Emergency Battery Pack EPC7 = 7W Emergency Battery Pack EPC10 = 10W Emergency Battery Pack EPC12 = 12W Emergency Battery Pack GTD = Generator Transfer Device EMC = Emergency Circuit TCW = Two Circuit Wiring
	TUNABLE WHITE & COLOR¹ <u>2-Channel White</u> 2DIM10 = for 0-10V 2DALI = for DALI 2DMX = for DMX 2PSQ = for Lutron 2SNS = for Signify 2CAS = for Casambi <u>3-Channel White</u> 3DML = for DLM <u>3-Channel Color</u> RGB <u>4-Channel Color/White</u> RGBW <u>5-Channel Color/Warm White/Cool White</u> RGBWW						

¹Tunable white, tunable color and RGB/W options detailed on page 3.

²Delivered Lumens are Standard Output (SO) and Low Output (LO) at 80+CRI 4000K CCT. Use the following multiplier to estimate delivered lumens at other CCTs: 2700K = 0.94, 3000K = 0.96, 3500K = 0.98, 5000K = 1.02. All values nominal. See page 2 for photometry.

³See page 2 for ceiling mounting options details and full specifications.



Cross Section & Mounting Options

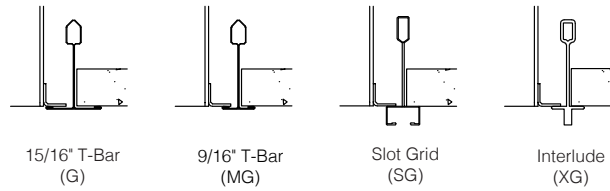
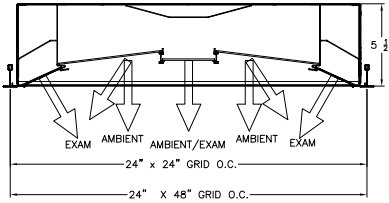

Drywall Ceiling

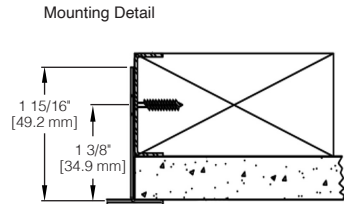

Flange Kit for drywall ceilings available:
FK-22 for 2x2

Grid Ceiling

Five-step Universal Installation Sequence.
Complete Installation Instructions for grid and drywall ceiling types are available at: www.dayolite.com

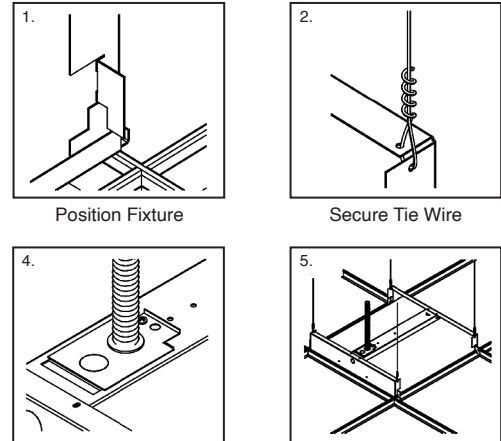

Photometry

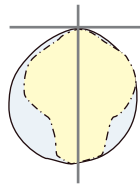

MEDL-TF-SI-40-SO-22
(Exam only)
CCT: 4000K
WATTS: 42
LUMENS: 4760
LPW: 113
Distribution:
100% Direct

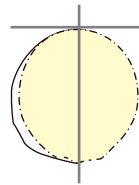

MEDL-TF-SI-40-SO-22
(Ambient only)
CCT: 4000K
WATTS: 28
LUMENS: 3080
LPW: 110
Distribution:
100% Direct

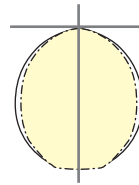

MEDL-TF-SI-40-SO-22
(Exam/Ambient)
CCT: 4000K
WATTS: 79
LUMENS: 7813
LPW: 99
Distribution:
100% Direct

Specifications

CONSTRUCTION: 20 gauge CRS housing and internal components.

OPTICS: Standard shielding is LED optimized Satin Ice (SI) acrylic ambient, and ribbed acrylic exam.

LED: LED modules in 27/30/35/40 & 50K CCT, 80 CRI (90CRI available). Lumen maintenance L_{70} = 50,000 hours. 3 SDCM color consistency.

DRIVER: Standard Class 2 AOC 0-10V to 1%, 120/277V input, PF > 90%, THD < 20 @ 120V. Additional dimming protocols available. All drivers prewired from factory for connection to control system (by others). -20°C to +50°C operating range. FCC Title 47 Part 15 Class A electromagnetic compliance. <24dB Class A sound rating. Field replaceable.

MOUNTING: Typical installation is in an exposed inverted T-bar ceiling. Fixtures are supplied with four support brackets for additional support to T-bar. May also be installed in a plaster ceiling (F with Flange).

FINISH: Housing and components finished in baked white enamel. SilverSan™ antimicrobial finish also available.

CERTIFICATION: Luminaires are cETLus listed conforming to UL STD. 1598 and certified to CSA STD C22.2 NO. 250.0. Suitable for dry & damp locations. Union Made in the United States of America. I.B.E.W. RoHS compliant.

Day-O-Lite offers a variety of tunable white and tunable color options for a range of human centric applications and budgets. It is recommended that a recognized authority on the benefits and best practices of tunable white be consulted prior to specification. As a rule, fewer channels will provide a basic level of performance for budget conscious applications. Conversely, an increased number of channels, a wider CCT range, higher CRI and more precise color consistency may be more appropriate depending on the application and desired results.

HOW TO SPECIFY

Select from the various channel/control options below and insert desired **Ordering Code** into the **COLOR TEMP** column of the Ordering Guide on page 1. No need to add a dimming option as the codes include the chosen protocol.

2-CHANNEL TUNABLE WHITE OPTIONS

2700K - 6500K CCT range
 1000L/ft LED modules @ 4000K
 80+ CRI w/3SDCM color accuracy
 10W/ft. nominal power

Ordering Codes

2DIM10 for 0-10V control
2DALI for DALI control
2DMX for DMX control
2PSQ for Lutron Quantum control
2SNS for control via Signify SNS sensors
2CAS for control via Casambi BLE wireless devices

LEGRAND BLANCO MULTI-CHANNEL OPTIONS

Blanco-2

Blanco-2 mixes two channels of white LEDs to approximate the blackbody curve for tunable white applications. CCT and intensity may be adjusted with controls by others.

3000K-5000K CCT range
 1000L/ft LED modules @ 4000K
 90+ CRI w/2SDCM color accuracy
 10W/ft. nominal power

Ordering Codes

B2DLM for DLM control

Blanco-3

Blanco-3 mixes three channels of white LEDs across a wider range of color temperatures for more demanding tunable white applications. CCT and intensity may be adjusted with controls by others.

2700K-6500K CCT range
 1000L/ft. LED modules @ 4000K
 90+ CRI w/SDCM color accuracy
 10W/ft. nominal power

Ordering Codes

B3DLM for DLM control

RGB & RGBW TUNABLE COLOR

RGB = Red, Green, Blue color mixing LEDs
 RGBW = Red, Green, Blue + White of chosen CCT
 Dimming form 100% to 1%.
 90+ CRI w/3SDCM color accuracy
 10W/ft. nominal power

Notes:

RGB requires an RGB DMX or DALI controller (by others)

RGBW requires an RGBW DMX or DALI controller (by others)

All channels on one driver is standard, if isolating the White from the RGB channels is desired please consult factory.

RGB and RGBW are not recommended for tunable white applications.

Ordering Codes

RGB for DMX control
RGB27 for DMX control w/2700K white
RGB30 for DMX control w/3000K white
RGB35 for DMX control w/3500K white
RGB40 for DMX control w/4000K white
RGB50 for DMX control w/5000K white
RGB65 for DMX control w/6500K white
 Add Suffix **DAL** for DALI Control to codes above.

5-CHANNEL TUNABLE WHITE AND COLOR

RGBWW = Red, Green, Blue, Warm White, Cool White.
 Consult factory for RGBWW tunable white/color options.

Day-O-Lite makes no claims as to the psychological or physiological efficacy of the white color tuning options offered herein.