

Date	Notes
Project	
Type	Qty

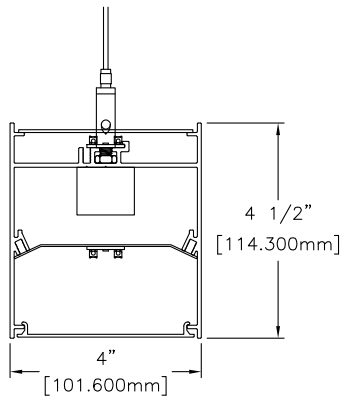

Indirect clear acrylic (CA) lens w/Direct flush lens (FL) shown. See page 6 for other lens details.



Features

Extruded aluminum housing w/welded end-plates.

LED optimized optics in multiple configurations up and down.

Direct/Indirect performance as a single circuit or individual up/down control with two circuits.

High efficiency programmable driver for custom lumen packages. 0-10V dimming to 1% standard.

High efficacy LEDs in 80 or 90 CRI; tunable white, tunable color.

Bios SkyBlue™ circadian technology available.



Note DLC options at bottom of page.

Ordering Guide

MODEL	OPTICS	CCT	LUMENS ⁴	LENGTH ⁵	MOUNTING	FINISH	OPTIONS
PRFL-44-DI							
PRFL-44-DI Direct/Indirect	<p>DIRECT LENS</p> <p>FL = Flush Opal Acrylic (Standard snap-in)</p> <p>DL = 1" Drop Opal Acrylic (snap-in)</p> <p>SI = Satin Ice Acrylic (lay-in)</p> <p>SIL = Satin Ice lens w/Internal Cross Baffle (white)</p> <p>INDIRECT LENS</p> <p>CA = Clear Acrylic (Standard lay-on)</p> <p>FL = Flush Opal Acrylic (snap-in)</p> <p>SI = Satin Ice Acrylic (lay-on)</p> <p>AS = Asymmetric (lay-on)</p> <p>CM = Collimating (lay-on)</p> <p>BW = Batwing (lay-on)</p>	<p>STATIC WHITE¹</p> <p>27 = 2700K</p> <p>30 = 3000K</p> <p>35 = 3500K</p> <p>40 = 4000K</p> <p>50 = 5000K</p> <p>BIOS SkyBlue²</p> <p>Spectrally optimized circadian solutions.</p> <p>TUNABLE WHITE³</p> <p>(2700K-6500K)</p> <p>2DIM10 = for 0-10V</p> <p>2DMX = for DMX</p> <p>2PSQ = for Lutron</p> <p>2SNS = for Philips</p> <p>2CAS = for Casambi</p> <p>RGB + WHITE³</p> <p>RGB = RGB</p> <p>RGBW = RGBW</p> <p>ADVANCED COLOR³</p> <p>125mm incremental pixel color control for chases and animated effects.</p>	<p>LO = 1163/ft (9.5W/ft, 121LPW)</p> <p>SO = 1590/ft (13W/ft, 122LPW)</p> <p>HO = 1900/ft (16.3W/ft, 116LPW)</p> <p>Consult factory for custom lumen packages.</p> <p>All values nominal.</p>	<p>2 = 2 ft</p> <p>3 = 3 ft</p> <p>4 = 4 ft</p> <p>5 = 5 ft</p> <p>6 = 6 ft</p> <p>7 = 7 ft</p> <p>8 = 8 ft</p> <p>For other enter row length (e.g. 48 = 48 ft)</p>	<p>AC = Aircraft Cable (standard)</p> <p>PD = Pendant Stem (standard)</p>	<p>W = White</p> <p>CC = Custom Color</p> <p>AMW = Anti-Microbial White</p>	<p>DIMMING DRIVERS</p> <p>DIM10 = 0-10V (1%) - Standard</p> <p>DIMSR = 0-10V (5.0%) Sensor Ready</p> <p>DIMST = Step Dimming (40%/100%)</p> <p>DALI = DALI (5.0%)</p> <p>LUTRON™ DIMMING DRIVERS</p> <p>LDE1 = Hi-Lume™ 1% EcoSystem™</p> <p>L3DA3W = Hi-Lume™ 1% 3-Wire</p> <p>SENSORS & CONTROLS</p> <p>ESN = Philips™ EasySense</p> <p>DAY = Daylight Harvesting</p> <p>OCC = Occupancy Sensor</p> <p>CAS = Casambi Bluetooth control</p> <p>VDO = Vive Sensor by Lutron</p> <p>AWNRS = Athena Wireless Node</p> <p>AWNS = Athena Wireless Sensor</p> <p>EMERGENCY</p> <p>EMC = Emergency Circuit</p> <p>GTD = Generator Transfer Device</p> <p>EPC4 = 4W Emergency Battery Pack</p> <p>EPC7 = 7W Emergency Battery Pack</p> <p>EPC10 = 10W Emergency Battery Pack</p> <p>EPC12 = 12W Emergency Battery Pack</p> <p>OTHER</p> <p>TCW = Two Circuit Wiring</p>

¹ CCT @ 80+CRI, 3SDCM. For 90CRI add prefix '9'; ex: 935 = 3500K, 90CRI.

² BIOS SkyBlue Biological Static & Dynamic page 3.

³ Tunable White, RGB +White and Advanced Color ordering codes page 2.

⁴ DLC options are limited to FL optics, static white 35/40K CCT @ 80CRI, SO lumens, all mounting, all finishes, and all options excluding DIMST.

⁵ See page 4 for actual fixture lengths and mounting locations.



TUNABLE WHITE - Fixture Level Control



Day-O-Lite offers Tunable White in a range from 2700K-6500K CCT @ 80+CRI and 3SDCM color accuracy for a range of two-channel control options. Consult factory for 90CRI, electrical specifications and other details for each option below.

2ESN Option combines tunable white light with a fixture integrated occupancy and daylight harvesting sensor. CCT and intensity is controlled wirelessly with kinetic switches (by Illumra and others). Occupancy and daylight harvesting controlled automatically with parameters configurable with the Philips MasterConnect app available for Android and iPhone smart phones.

Applications:

- Spaces occupied overnight (~ 7pm to 7am)
- 24-hour spaces
- Shiftwork & Hospitals
- Senior Living, Alzheimer's Dementia & Assisted Living
- Higher Education, including student and staff
- Workplace, including areas occupied after 7pm

Ordering Codes:

2DIM10 = 0-10V
2DMX = DMX
2PSQ = Lutron Athena and Quantum
2CAS = Casambi Wireless
2ESN = Philips EasySense

RGB + WHITE - Fixture Level Control



Combine RGB for color effects with LO/SO/HO white CCT's for **general illumination** in a host of applications. All options require DMX control (by others). 80CRI w/3SDCM color accuracy is standard. Consult factory for 90CRI, electrical specifications and other details for each option below. May not be compatible with all fixture variations - consult factory for details when ordering.

Applications:

- Entertainment Spaces
- Hospitality & Banquet
- Theatre & Stage
- Seasonal Applications
- Branding
- Wayfinding

Ordering Codes:

RGB = RGB only
RGB27 = RGB w/2700K
RGB30 = RGB w/3000K
RGB35 = RGB W/3500K
RGB40 = RGB w/4000K
RGB50 = RGB w/5000K

ADVANCED COLOR - 125mm Pixel Level Control



Day-O-Lite's Advanced Color options combine RGB or RGBW with multi-pixel control for advanced **chases**, animated **visual effects** and other programmable scenes with **125 mm pixel** granularity. Choose from a vibrant color palette with RGB or RGBW LEDs for seamless color mixing and dimming - the perfect replacement for glass neon with improved reliability and durability.

Requires configuration with a remote proprietary digital drive power supply. Auto-addressing makes setup and commissioning quick and easy. DMX (by others) required for control. May not be compatible with all fixture variations - consult factory for details when ordering.

Applications:

- Architectural Installations
- Digital Signage
- Arcades, Clubs
- Theatre & Stage
- Film & TV sets
- Indoor/Outdoor (IP66)

Ordering Codes:

ACRGB = RGB only
AC27 = RGB w/2700K
AC30 = RGB w/3000K
AC40 = RGB w/4000K

BIOS SkyBlue

BIOS SkyBlue biological technology brings the benefits of blue skies inside. BIOS SkyBlue is the only spectrally optimized circadian solution to pinpoint the region that drives wellness benefits including: increased alertness, enhanced productivity, better mood, and better sleep. More information may be found at www.bioslighting.com or by contacting Day-O-Lite directly.

BIOS Biological Static - Daytime Solution

BIOS Biological Static solutions are designed for daytime applications. BIOS Static Biological LED features key BIOS SkyBlue™ (490nm) for maximum daytime circadian impact. BIOS Static Biological LED Light Engines are available in 3000K, 3500K, and 4000K. Lighting controls are easy; simply switch the lights on/off or the lights can be dimmed using a single-channel constant current (CC) LED driver with any standard dimming interface.

Applications:

- Spaces occupied during the daytime ~7am – 7pm
- K-12 Schools / Higher Education
- Offices
- Daytime Adult Care Facilities
- Medical Offices

BIOS Biological Static
Ordering Codes:

- B30** = 3000K
- B35** = 3500K
- B40** = 4000K

BIOS Biological Static 3500K

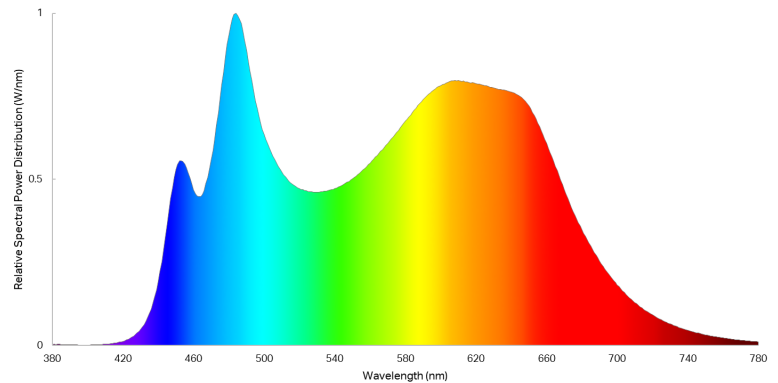

BIOS Biological Dynamic - Day & Night Solution A

BIOS Biological Dynamic solutions are designed to transition from daytime to evening in a dim-to-warm protocol. The daytime CCT includes full BIOS SkyBlue™ (490nm) for maximum daytime circadian impact, while the evening spectrum removes BIOS SkyBlue™ altogether, providing a minimal circadian stimulus after hours. Available in 3000K-2700K, 3500K-3000K and 4000K-3500K. Simply dim the lights in the evening to remove the daytime SkyBlue wavelengths (490nm) and convert your lights from day mode to night mode via a single controller (0-10V, ELV, DMX, Wireless).

BIOS Biological Tunable White - Day & Night Solution B

BIOS Biological Tunable solutions are designed to transition from daytime to evening in a dim-to-warm protocol. The daytime CCT includes full BIOS SkyBlue™ (490nm) for maximum daytime circadian impact, while the evening spectrum removes BIOS SkyBlue™ altogether, providing a minimal circadian stimulus after hours. Available in 3000K-2700K, 3500K-3000K and 4000K-3500K. Simply dim the lights in the evening to remove the daytime SkyBlue wavelengths (490nm) and convert your lights from day mode to night mode via a single controller (0-10V, ELV, DMX, Wireless).

BIOS Biological Tunable is also compatible with two-channel color tuning systems. Simply dim the lights in the evening to convert your lights from day mode to night mode via a multi-channel controller (0-10V, ELV, DMX, Wireless). 3000K, 3500K and 4000K CCTs all dim to 2700K.

Applications:

- Spaces occupied overnight (~ 7pm to 7am)
- 24-hour spaces
- Shiftwork & Hospitals
- Senior Living, Alzheimer’s Dementia & Assisted Living
- Higher Education, including student and staff
- Workplace, including areas occupied after 7pm

BIOS Biological
Dynamic White
Ordering Codes:

- B30D** = 3000K-2700K
- B35D** = 3500K-3000K
- B40D** = 4000K-3500K

BIOS Biological
Tunable White
Ordering Codes:

- B30T** = 3000K-2700K
- B35T** = 3500K-2700K
- B40T** = 4000K-2700K

BIOS Biological Dynamic 3500K

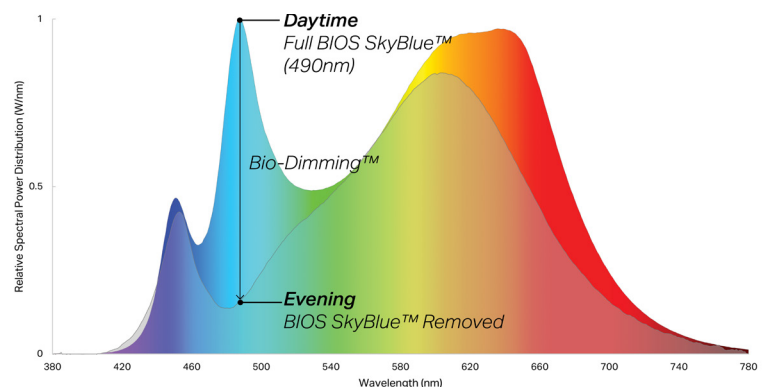

Individual Fixtures & Continuous Rows

NOMINAL LENGTH	ACTUAL LENGTH	SUSP. 1 O.C.	SUSP. 2 O.C.	SUSP. 3 O.C.
4'	3' 8-1/2"	41 1/2"		
8'	7' 5"	86		
12'	11' 1-1/2"	86	44 1/2"	
16'	14' 10"	86	89	
20'	18' 6-1/2"	86	89	44 1/2"
24'	22' 3"	86	89	89

Individual fixtures and rows are continuously illuminated and joined with included aligner brackets and hardware. Power feed locations and mounting locations are shown below.

Continuous rows longer than 8' and patterns, including EPC/EMC and sensor locations must be approved prior to manufacturing. See below for specifying patterns.

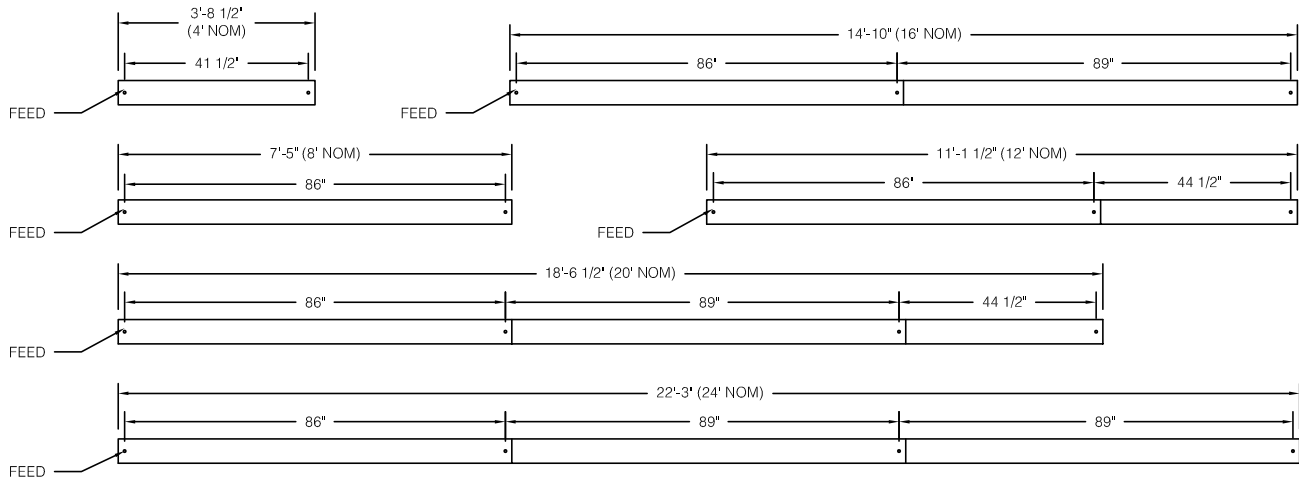

Emergency & Sensor Locations

EPC will control entire length of individual fixtures. Individual fixtures of differing lengths will deliver the same lumens under EPC power (a 4' fixture will deliver the same total lumens over half the length of an 8' fixture). EMC controlled individual fixtures will deliver lumens per foot as originally specified, unless dimmed at time of power loss. Consult factory for EMC dimming override device.

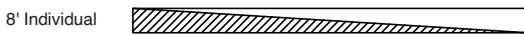

For individual fixtures to 8' EPC/EMC will power entire fixture.

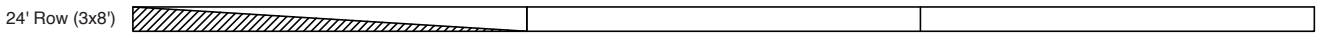

For continuous rows longer than 8' one EPC/EMC will be located in the feed section (end-left) of the row as shown below.

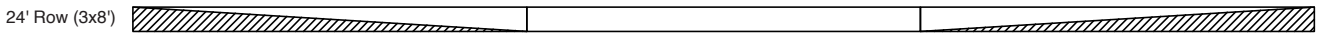

If two EPC/EMC's are required their default locations will be in the feed section (end-left) and last section (end-right) as below.



Custom placement of one or more EPC/EMC's must be clearly identified during ordering.



SENSORS (Integral) for individual fixtures will control entire length of fixture and will be located on feed end of fixture.

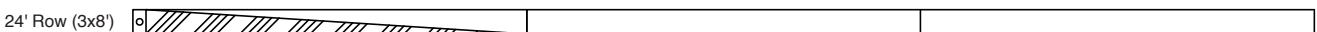

SENSORS for rows by default will control the feed section (end-left) of the row. Sensors can control more than an 8' section within a row. Consult factory for sensor/section options, or for multiple sensors in a continuous row.

Pattern Guide

Profile may be specified in patterns of virtually any configuration. All patterns and corners are continuously illuminated and joined with included aligner brackets and joining hardware. See examples below for suggestions with actual and nominal dimensions. Day-O-Lite's custom manufacturing capabilities allow the specification of custom angled connectors to make non-square patterns possible. (See ILX example below).

All corners and connectors are fully welded to ensure correct dimensions and "square" joinery when assembled.

How to Specify

1. Submit your pattern to Day-O-Lite in dimensioned CAD file or submit a fully dimensioned PDF file.
2. If EPC/EMC or Sensors are to be included their location needs to be clearly noted.
3. Day-O-Lite will design your pattern to as close as is nominally possible given standard LED module lengths, including connectors.
4. Day-O-Lite will supply a detailed drawing for approval with final dimensions. All patterns must be approved prior to manufacture.

Pattern Examples

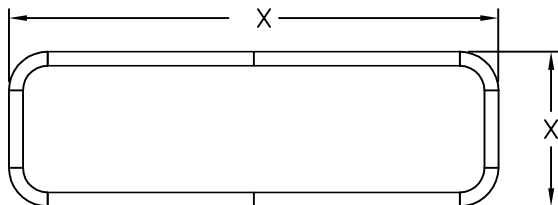
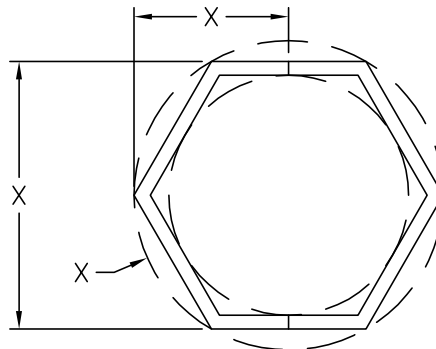
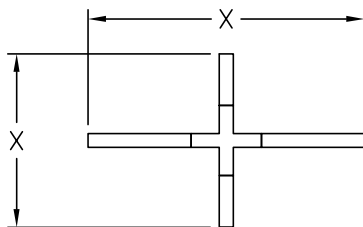
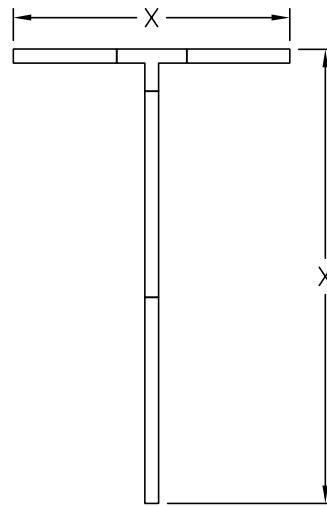
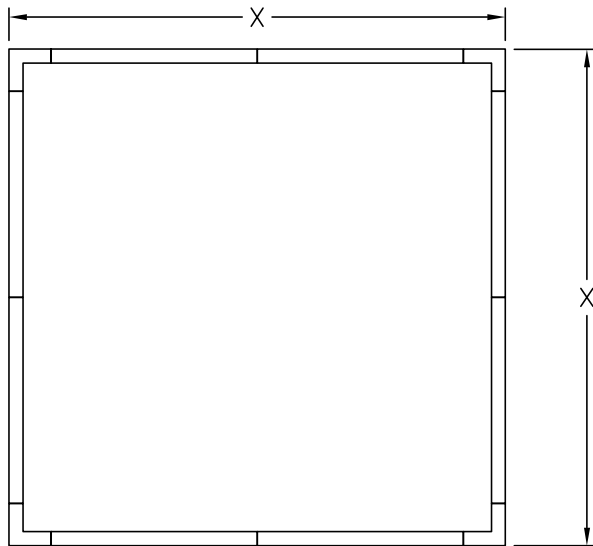

Illuminated Connectors

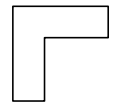

ILC2 = 90° Corner

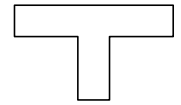

ILC3 = 90° Tee

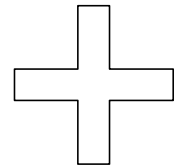

ILC4 = 90° Cross

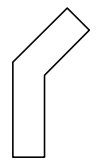

ILCX = X° Custom



ILCR = Custom Radius
12" Min.

Standard Suspensions

Standard suspension options include adjustable self-locking aircraft cables (AC) and rigid pendant stems (PD). AC assembly is 48" x 1/16" with a 5" feed canopy and 2" suspension canopies. 60" 18 gauge power and 22 gauge dimming control SJT feed. PD assemblies are 5/8" dia. (or 3/8" IP) hollow stem for power feed by others, 24" is standard. Consult factory for longer suspension lengths and other mounting options.

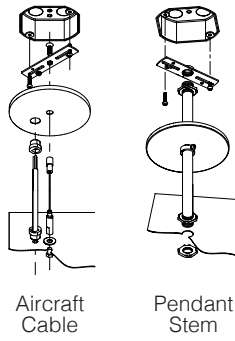

Additional Lens Details

Photometry

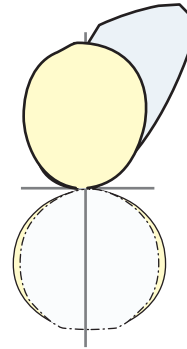
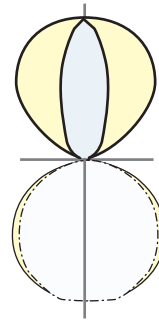
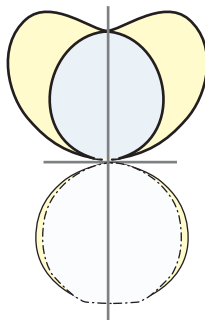
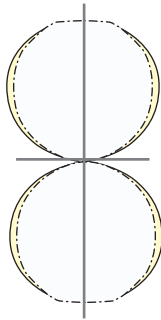

PRFL-24-DI-FL-40-SO-4
Flush/Clear Lens (FL/CA)

PRFL-24-DI-BW-40-SO-4
Bat Wing Lens (BW)

PRFL-24-DI-CM-40-SO-4
Collimating Lens (CM)

PRFL-24-DI-AS-40-SO-4
Asymmetrical Lens (AS)

4000K CCT
WATTS: 52
LUMENS: 6360
LPW: 122
Distribution:
43% Direct, 57% Indirect
DLC V5.1 listed

Lens Details

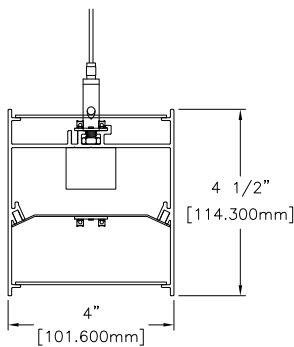

Satin Ice Lens (SI)

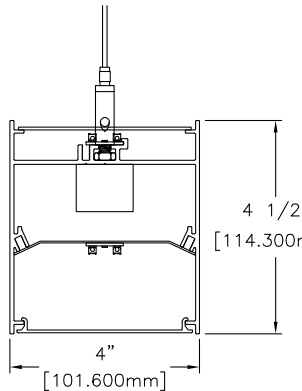

Drop Lens (DL)

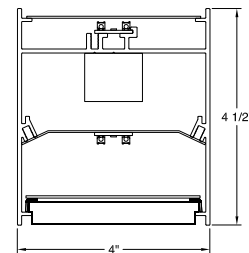

Satin Ice Lens
Internal Cross
Blade (SIL)

Specifications

CONSTRUCTION Extruded aluminum housing. 20 gauge cold rolled steel internal components.

REFLECTOR Die-formed steel finished in highly reflective baked white enamel with pre-finished reflective LED tray.

OPTICS LED optimized direct Satin Ice (SI) lay-in, opal acrylic flush (FL) and opal acrylic drop (DL) lenses available. Diffuse Polycarbonate (DP) lay-in lens available for matching ARCL-44-DI series. Indirect (CA) clear acrylic, (AS) Asymmetric, (CM) Collimating and (BW) Bat Wing available.

LED Static white LED modules in 30/35/40 & 50K CCT, 80/90CRI. Lumen maintenance minimum $L_{70}=50,000$ hours. 3 SDCM color consistency. BIOS SkyBlue, RGB, RGBW and Tunable White options available.

DRIVER Standard driver is Class 2 AOC 0-10V to 1%, 120/277V input, PF > 90%, THD < 20 @ 120V. Additional dimming protocols available. All drivers prewired from factory for connection to control system (by others). Field replaceable.

MOUNTING Standard options include adjustable self-locking aircraft cables (AC), and rigid pendant stems (PD). AC assembly is 48" x 1/16" with a 5" feed canopy and 2" suspension canopies. 18 gauge power and 22 gauge dimming control SJT feed.

FINISH Housing and components finished in baked white enamel. Canopies and pendant stems are white enamel unless otherwise specified.

CERTIFICATION Luminaires are cETLus listed conforming to UL STD. 1598 and certified to CSA STD C22.2 NO. 250.0. Suitable for dry & damp locations. Union Made in the United States of America. I.B.E.W. RoHS compliant. DLC V5.1 listed.