



Profile Series | PRFL-24-D Acoustic

Date		Notes
Project		
Type	Qty	



20 unique colors & 4 wood grain finishes.

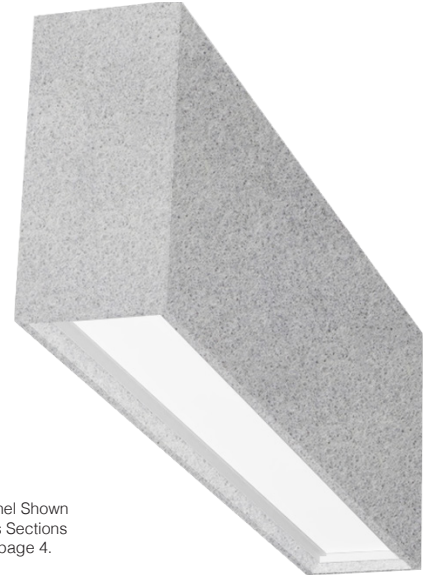

8" Panel Shown
Cross Sections
on page 4.

Features

- Combines noise control and illumination in a simple lighting and acoustic solution.
- Boosts human performance by reducing distracting noise levels and reverberations.
- Promotes an inviting space for personal wellbeing, focus and concentration.
- Improves privacy during sensitive communication by reducing echoes and reflected sound.
- Creates a decorative floating ceiling in otherwise open-ceiling interior applications.
- A **Declare** Red List Approved product.

Ordering Guide

MODEL	OPTICS	CCT	LUMENS	LENGTH ⁴	MOUNTING ⁵	FINISH	OPTIONS
PRFL-24-D							
PRFL-24-D Direct Acoustic	FL = Flush Opal Acrylic (snap-in) DL = 1" Drop Opal Acrylic (snap-in) SI = Satin Ice Acrylic (lay-in) SCB = Internal Cross Blade w/SI Lens (white)	STATIC WHITE¹ 27 = 2700K 30 = 3000K 35 = 3500K 40 = 4000K 50 = 5000K BIOS SkyBlue² Spectrally optimized circadian solutions. TUNABLE WHITE³ (2700K-6500K) 2DIM10 = for 0-10V 2DMX = for DMX 2PSQ = for Lutron 2ESN = for Philips 2CAS = for Casambi DIM-TO-WARM (2700K-6500K) DTW = Dim-to-Warm RGB + WHITE³ RGB = RGB RGBW = RGBW ADVANCED COLOR³ 125mm incremental pixel color control for chase and animated effects.	LO = 480/ft (5W/ft, 92LPW) SO = 640/ft (7W/ft, 92LPW) HO = 800/ft (11W/ft, 91LPW) All outputs are for 12" high acoustic solution. Consult factory for custom lumen packages. All values nominal.	2 = 2 ft 3 = 3 ft 4 = 4 ft 5 = 5 ft 6 = 6 ft 7 = 7 ft 8 = 8 ft For other enter row length (e.g. 12 = 12 ft)	AC = Aircraft Cable PD = Pendant Stem	FIXTURE HOUSING W = White CC = Custom Color ACOUSTIC SOLUTIONS See page 4 for Acoustic color options, ordering codes and technical information.	ACOUSTIC OPTIONS See page 4 for acoustic options ordering codes and information. DIMMING DRIVERS DIM10 = 0-10V (1%) - Standard DIMCF = Dim-to-Off (Comfort Fade) DIMOF = Dim-to-Off DIMSR = 0-10V (5.0%) Sensor Ready DIMST = Step Dimming (40%/100%) DALI = DALI (5.0%) DMX = DMX LUTRON™ DIMMING DRIVERS LDE1 = Hi-Lume™ 1% EcoSystem™ L3DA3W = Hi-Lume™ 1% 3-Wire SENSORS & CONTROLS ESN = Philips™ EasySense DAY = Daylight Harvesting OCC = Occupancy Sensor CAS = Casambi Bluetooth control VDO = Vive Sensor by Lutron AWNR = Athena RF/Node AWNS = Athena Wireless Sensor EMERGENCY EMC = Emergency Circuit EPC7 = 7W Emergency Battery Pack Consult factory for other wattages.

¹CCT @ 80+CRI, 3SDCM. For 90CRI add prefix *9; ex: 935 = 3500K, 90CRI.

²BIOS SkyBlue Biological Static & Dynamic page 3.

³Tunable White, RGB +White and Advanced Color ordering codes page 2.

⁴Actual fixture lengths and suspension locations page 5.

⁵See page 6 for suspension details.



TUNABLE WHITE - Fixture Level Control



Day-O-Lite offers Tunable White in a range from 2700K-6500K CCT @ 80+CRI and 3SDCM color accuracy for a range of two-channel control options. Consult factory for 90CRI, electrical specifications and other details for each option below.

2ESN Option combines tunable white light with a fixture integrated occupancy and daylight harvesting sensor. CCT and intensity is controlled wirelessly with kinetic switches (by Illumra and others). Occupancy and daylight harvesting controlled automatically with parameters configurable with the Philips MasterConnect app available for Android and iPhone smart phones.

Applications:

- Spaces occupied overnight (~ 7pm to 7am)
- 24-hour spaces
- Shiftwork & Hospitals
- Senior Living, Alzheimer's Dementia & Assisted Living
- Higher Education, including student and staff
- Workplace, including areas occupied after 7pm

Ordering Codes:

- 2DIM10** = 0-10V
- 2DMX** = DMX
- 2PSQ** = Lutron Athena and Quantum
- 2CAS** = Casambi Wireless
- 2ESN** = Philips EasySense

RGB + WHITE - Fixture Level Control



Combine RGB for color effects with LO/SO/HO white CCT's for **general illumination** in a host of applications. All options require DMX control (by others). 80CRI w/3SDCM color accuracy is standard. Consult factory for 90CRI, electrical specifications and other details for each option below. May not be compatible with all fixture variations of - consult factory for all details when ordering.

Applications:

- Entertainment Spaces
- Hospitality & Banquet
- Theatre & Stage
- Seasonal Applications
- Branding
- Wayfinding

Ordering Codes:

- RGB** = RGB only
- RGB27** = RGB w/2700K
- RGB30** = RGB w/3000K
- RGB35** = RGB w/3500K
- RGB40** = RGB w/4000K
- RGB50** = RGB w/5000K

ADVANCED COLOR - 125mm Pixel Level Control



Day-O-Lite's Advanced Color options combine RGB or RGBW with multi-pixel control for advanced **chases**, animated **visual effects** and other programmable scenes with **125 mm pixel** granularity. Choose from a vibrant color palette with RGB or RGBW LEDs for seamless color mixing and dimming - the perfect replacement for glass neon with improved reliability and durability.

Requires configuration with a remote proprietary digital drive power supply. Auto-addressing makes setup and commissioning quick and easy. DMX (by others) required for control. May not be compatible with all fixture variations of - consult factory for all details when ordering.

Applications:

- Architectural Installations
- Digital Signage
- Arcades, Clubs
- Theatre & Stage
- Film & TV sets
- Indoor/Outdoor (IP66)

Ordering Codes:

- ACRGB** = RGB only
- AC27** = RGB w/2700K
- AC30** = RGB w/3000K
- AC40** = RGB w/4000K

BIOS SkyBlue

BIOS SkyBlue biological technology brings the benefits of blue skies inside. BIOS SkyBlue is the only spectrally optimized circadian solution to pinpoint the region that drives wellness benefits including: increased alertness, enhanced productivity, better mood, and better sleep. More information may be found at www.bioslighting.com or by contacting Day-O-Lite directly.

BIOS Biological Static - Daytime Solution

BIOS Biological Static solutions are designed for daytime applications. BIOS Static Biological LED features key BIOS SkyBlue™ (490nm) for maximum daytime circadian impact. BIOS Static Biological LED Light Engines are available in 3000K, 3500K, and 4000K. Lighting controls are easy; simply switch the lights on/off or the lights can be dimmed using a single-channel constant current (CC) LED driver with any standard dimming interface.

Applications:

- Spaces occupied during the daytime ~7am – 7pm
- K-12 Schools / Higher Education
- Offices
- Daytime Adult Care Facilities
- Medical Offices

BIOS Biological Static
Ordering Codes:

- B30** = 3000K
- B35** = 3500K
- B40** = 4000K

BIOS Biological Static 3500K

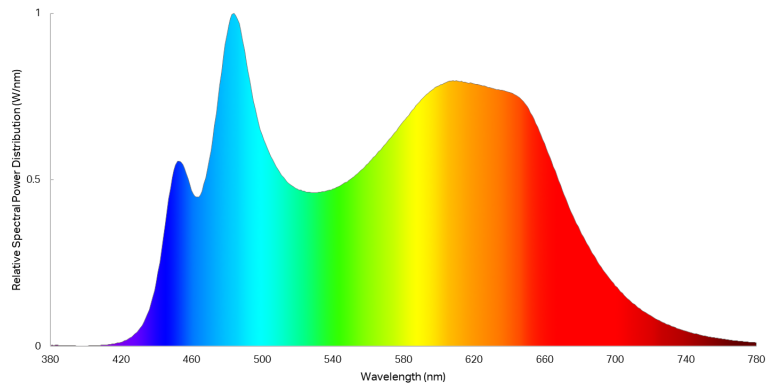

BIOS Biological Dynamic - Day & Night Solution A

BIOS Biological Dynamic solutions are designed to transition from daytime to evening in a dim-to-warm protocol. The daytime CCT includes full BIOS SkyBlue™ (490nm) for maximum daytime circadian impact, while the evening spectrum removes BIOS SkyBlue™ altogether, providing a minimal circadian stimulus after hours. Available in 3000K-2700K, 3500K-3000K and 4000K-3500K. Simply dim the lights in the evening to remove the daytime SkyBlue wavelengths (490nm) and convert your lights from day mode to night mode via a single controller (0-10V, ELV, DMX, Wireless).

BIOS Biological Tunable White - Day & Night Solution B

BIOS Biological Tunable solutions are designed to transition from daytime to evening in a dim-to-warm protocol. The daytime CCT includes full BIOS SkyBlue™ (490nm) for maximum daytime circadian impact, while the evening spectrum removes BIOS SkyBlue™ altogether, providing a minimal circadian stimulus after hours. Available in 3000K-2700K, 3500K-3000K and 4000K-3500K. Simply dim the lights in the evening to remove the daytime SkyBlue wavelengths (490nm) and convert your lights from day mode to night mode via a single controller (0-10V, ELV, DMX, Wireless).

BIOS Biological Tunable is also compatible with two-channel color tuning systems. Simply dim the lights in the evening to convert your lights from day mode to night mode via a multi-channel controller (0-10V, ELV, DMX, Wireless). 3000K, 3500K and 4000K CCTs all dim to 2700K.

Applications:

- Spaces occupied overnight (~ 7pm to 7am)
- 24-hour spaces
- Shiftwork & Hospitals
- Senior Living, Alzheimer’s Dementia & Assisted Living
- Higher Education, including student and staff
- Workplace, including areas occupied after 7pm

BIOS Biological
Dynamic White
Ordering Codes:

- B30D** = 3000K-2700K
- B35D** = 3500K-3000K
- B40D** = 4000K-3500K

BIOS Biological
Tunable White
Ordering Codes:

- B30T** = 3000K-2700K
- B35T** = 3500K-2700K
- B40T** = 4000K-2700K

BIOS Biological Dynamic 3500K

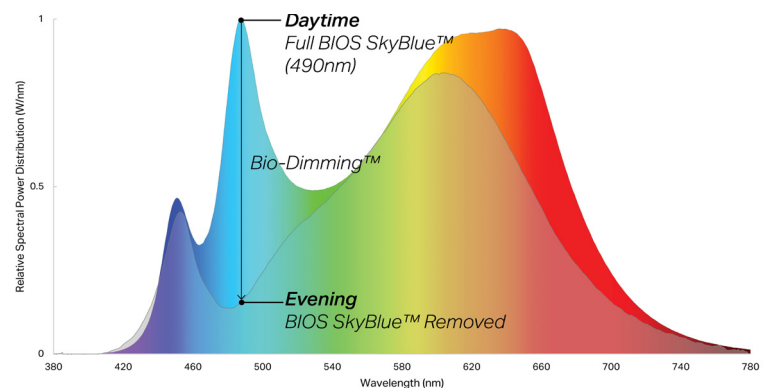

Day-O-Lite's acoustic options integrate energy efficient architectural lighting with advanced sound absorbing technology in a sustainable, eco-friendly solution. Functional, attractive and easy to install, Day-O-Lite's acoustic solutions are ideal for use in educational, office, commercial, theatre and lobby applications.



HOW TO SPECIFY

- 1) Select color code from color swatches above.
- 2) Select height of acoustic panel - 8", 12" or 16".
- 3) Combine color and height to make complete code. Example: SK-12 = Sky, 12" high, FO-8 = Fossil, 8" high.
- 4) Enter completed code in Options section of Ordering Guide on page 1 of this Specification Sheet.

SPECIFICATIONS

- 100% Recyclable Polyester Material
- 1.6 Noise Reduction Coefficient (NRC)
- Class A Fire Rating
- Moisture and Mold Resistant
- UV Fade Resistant
- Stain repellent available

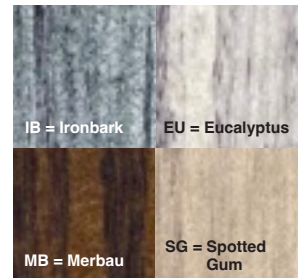

NON-ILLUMINATED BAFFLES

Non-Illuminated baffles matching the color and size of specified fixtures may also be ordered. These may be used as "fillers" between fixtures for added sound suppression, or alone as decorative elements. Specify as follows: PRFL-14-NIB (non-illuminated baffle)-XX (color)-YY (panel height). Example: PRFL-14-NIB-SL-16 = Profile 14 size, non-illuminated baffle, Slate color, 16" high panel. Day-O-Lite non-illuminated baffles are supplied with the same aircraft cable suspension as our acoustic luminaires and feature a closed bottom with a bevel detail to match fixtures and may be specified as individual units to 8', or as continuous rows.

ADDITIONAL INFORMATION

Smoke, Pewter and Slate are standard colors; consult factory for lead-times on other colors. Acoustic panels ship affixed to luminaires and are held in place by stop-blocks and double-sided tape to prevent bowing. Onsite removal may result in damage and void warranty. Fixtures must be stored and installed in an interior dry location at a minimum of 52F.

A NOTE ON SOUND ABSORPTION

Per ASTM C423 there is no standard way to calculate sound absorption coefficients of non-standard shapes, sizes or spacing of material. Day-O-Lite's acoustic fixtures are tested using ASTM E795-16 Standard "Practices for Mounting Test Specimens During Sound Absorption Test", resulting in a noise reduction coefficient (NRC) unique to the test setup. When comparing sound suppressing materials those with a higher NRC will absorb more sound than those with a lower NRC, assuming the same test method is employed.

Additionally, more sound absorbing material in a space will result in greater sound suppression than less. Acoustic fixtures with 16" tall panels will be more effective at sound absorption than those with 8" or 12" high panels.

The full Acoustic Test Report, Certified Letter of Apparent NRC and Storage, Cleaning and Care information is available at www.dayolite.com.

CUSTOM ACOUSTICS

Acoustic Solutions may also be ordered in custom panel heights and with other custom modifications. Please contact Day-O-Lite directly to discuss your custom acoustic solutions today.

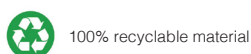
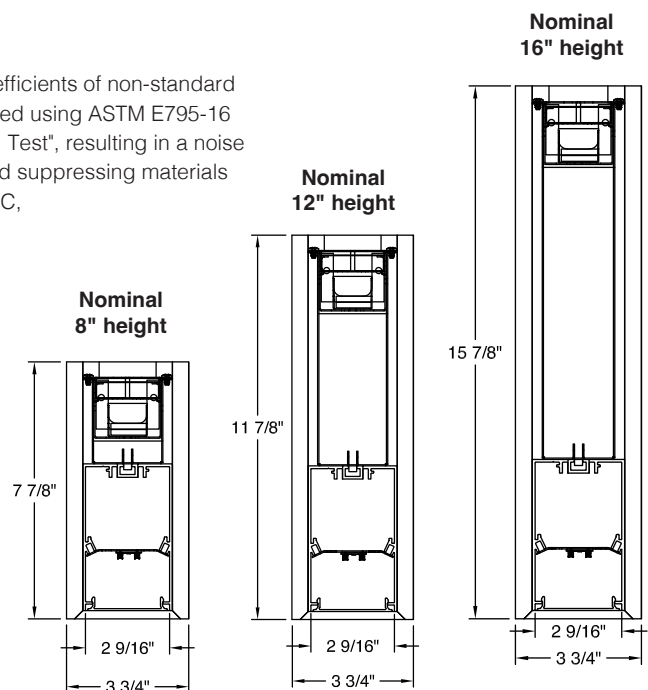

Individual Fixtures & Continuous Rows

NOMINAL LENGTH	ACTUAL LENGTH	SUSP. 1 O.C.	SUSP. 2 O.C.
4'	48"	42 3/4"	
8'	96"	90 3/4"	
12'	11'-11"	90 3/4"	47"
16'	15'-11"	90 3/4"	95"

Individual fixtures and rows are continuously illuminated and joined with included aligner brackets and hardware. Mounting locations shown below.

Continuous rows longer than 8', including EPC/EMC and sensor locations must be approved prior to manufacturing.

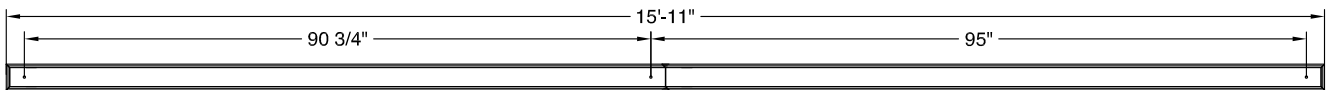
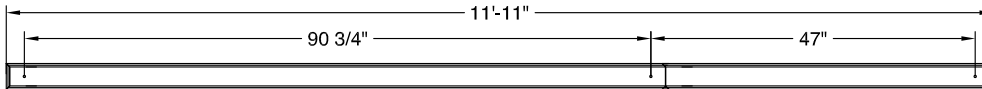
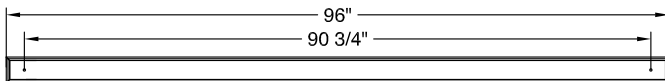
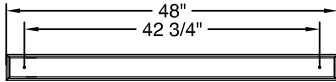

Emergency & Sensor

EPC will control entire length of individual fixtures. Individual fixtures of differing lengths will deliver the same lumens under EPC power (a 4' fixture will deliver the same total lumens over half the length of an 8' fixture). EMC controlled individual fixtures will deliver lumens per foot as originally specified, unless dimmed at time of power loss. Consult factory for EMC dimming override device.

INTEGRAL EM-BATTERY (EPC) AND EM-CIRCUIT (EMC) LOCATIONS

For individual fixtures to 8' EPC/EMC will power entire fixture.



For continuous rows longer than 8' one EPC/EMC will be located in the feed section (end-left) of the row as shown below.

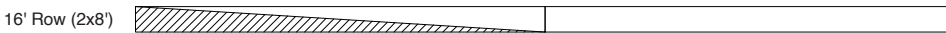

If two EPC/EMC's are required their default locations will be in the feed section (end-left) and last section (end-right) as below. Custom placement of one or more EPC/EMC's must be clearly identified during ordering.

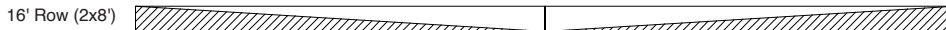

INTEGRAL SENSOR (OCC/DAY) LOCATIONS

SENSORS (Integral) for individual fixtures will control entire length of fixture and will be located on feed end of fixture.



SENSORS for rows by default will control the feed section (end-left) of the row. Sensors can control more than an 8' section within a row. Consult factory for sensor/section options, or for multiple sensors in a continuous row.

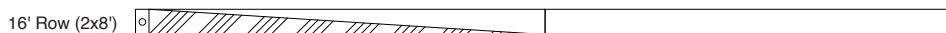

Standard Suspensions

Standard suspension options include adjustable self-locking aircraft cables (AC) and rigid pendant stems (PD). AC assembly is 48" x 1/16" with a 5" feed canopy and 2" suspension canopies. 60" 18 gauge power and 22 gauge dimming control SJT feed.

PD assemblies are 5/8" dia. (or 3/8" IP) hollow stem for power feed by others, 24" is standard. Consult factory for longer suspension lengths and other mounting options.

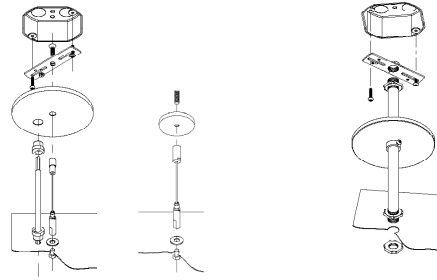

AC = Aircraft Cable

PD = Pendant Stem

Photometry

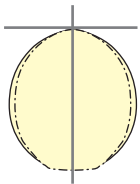

PRFL-24-D-FL-40-4
Satin Ice Lens

LO

4000K CCT
WATTS: 21
LUMENS: 1927
LPW: 92
Distribution:
100% Direct

SO

4000K CCT
WATTS: 28
LUMENS: 2564
LPW: 92
Distribution:
100% Direct

HO

4000K CCT
WATTS: 35
LUMENS: 3193
LPW: 91
Distribution:
100% Direct

Specifications

ACOUSTIC PANELS 1/2" thick, 100% recyclable polyester material, Class A fire rating, moisture, mold and UV fade resistant.

CONSTRUCTION Extruded aluminum housing. 20 gauge cold rolled steel internal components.

REFLECTOR Die-formed steel finished in highly reflective baked white enamel with pre-finished reflective LED tray.

OPTICS LED optimized opal acrylic flush (FL) and opal acrylic drop (DL) snap-in lenses or Satin Ice (SI) lay-in lens.

LED LED modules in 30/35/40 & 50K CCT, 80/90CRI. Lumen maintenance minimum $L_{70} = 50,000$ hours. 3 SDCM color consistency.

DRIVER: Standard driver is Class 2 AOC 0-10V to 1%, 120/277V input, PF > 90%, THD < 20 @ 120V. Additional dimming protocols available. All drivers prewired from factory for connection to control system (by others). Field replaceable.

MOUNTING: Standard options include adjustable self-locking aircraft cables (AC), and rigid pendant stems (PD). AC assembly is 48" x 1/16" with a 5" feed canopy and 2" suspension canopies. 18 gauge power and 22 gauge dimming control SJT feed.

FINISH Housing and components finished in baked white enamel. Canopies and pendant stems are white enamel unless otherwise specified.

CERTIFICATION Luminaires are cETLus listed conforming to UL STD. 1598 and certified to CSA STD C22.2 NO. 250.0. Suitable for dry & damp locations. Union Made in the United States of America. I.B.E.W. RoHS compliant and Declare Red List Approved.