

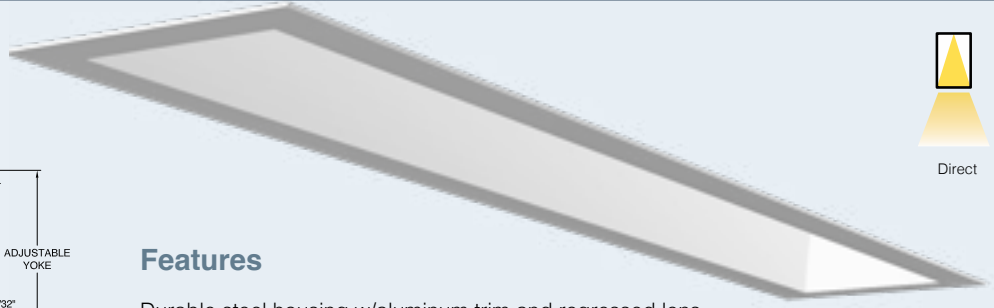

# Gemini | GEML-1919-D Flange

Date	Notes
Project	
Type Qty	

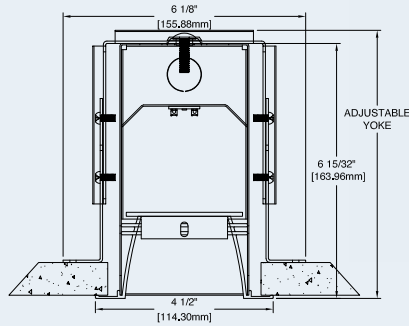

## Features

- Durable steel housing w/aluminum trim and regressed lens.
- LED optimized optics for smooth illumination end-to-end.
- Flange mount for individual fixtures or continuously illuminated rows.
- Hi-efficiency programmable driver for custom lumen levels. 0-10V dimming to 1%.
- Hi-efficacy LEDs in 80/90 CRI; two or three channel tunable white; 5-channel tunable color.

## Ordering Guide

MODEL	OPTICS	CCT <sup>1</sup>	LUMENS <sup>2</sup>	LENGTH <sup>3</sup>	MOUNTING	FINISH	OPTIONS
<b>GEML1919-D</b>	<b>SI</b>				<b>F</b>		
GEML-1919-D Direct	SI = Satin Ice Acrylic	27 = 2700K 80CRI 30 = 3000K 80CRI 35 = 3500K 80CRI 40 = 4000K 80CRI 50 = 5000K 80CRI  90 CRI add "9" Ex: 940 = 4000K @ 90 CRI	LO = 430/ft (5W/ft, 82LPW) SO = 575/ft (7W/ft, 82LPW) HO = 700/ft (9W/ft, 78LPW)	2 = 2 ft 3 = 3 ft 4 = 4 ft 5 = 5 ft 6 = 6 ft 7 = 7 ft 8 = 8 ft  For other enter row length (e.g. 48 = 48 ft)	F = Flanged	W = White CC = Custom Color AMW = Anti-Microbial White	<b>DIMMING DRIVERS</b> DIM10 = 0-10V (1%) - <b>Standard</b> DIMSR = 0-10V (5.0%) Sensor Ready DIMST = Step Dimming (40%/100%) DALI = DALI (5.0%)  <b>LUTRON™ DIMMING DRIVERS</b> LDE1 = Hi-Lume™ 1% EcoSystem™ LDE5 = 5-Series 5% EcoSystem™ L3DA3W = Hi-Lume™ 1% 3-Wire LTEA2W = Hi-Lume 1% 2-Wire 120V  <b>SENSORS &amp; CONTROLS</b> ESN = Philips™ EasySense DAY = Daylight Harvesting OCC = Occupancy Sensor CAS = Casambi Bluetooth control VDO = Vive Sensor by Lutron  <b>EMERGENCY</b> EMC = Emergency Circuit GTD = Generator Transfer Device EPC4 = 4W Emergency Battery Pack EPC7 = 7W Emergency Battery Pack EPC10 = 10W Emergency Battery Pack EPC12 = 12W Emergency Battery Pack
		<b>TUNABLE WHITE &amp; COLOR<sup>1</sup></b>  <u>2-Channel White</u> 2DIM10 = for 0-10V 2DALI = for DALI 2DMX = for DMX 2PSQ = for Lutron 2SNS = for Signify 2CAS = for Casambi  <u>3-Channel White</u> 3DML = for DLM  <u>3-Channel Color</u> RGB  <u>4-Channel Color/White</u> RGBW  <u>5-Channel Color/Warm White/Cool White</u> RGBWW	Consult factory for additional lumen packages.  All values are nominal.				

<sup>1</sup>Tunable white, tunable color and RGB/W options detailed on page 4.

<sup>2</sup>Delivered Lumens are Standard Output (SO) and Low Output (LO) at 80+CRI 4000K CCT. Use the following multiplier to estimate delivered lumens at other CCTs: 2700K = 0.94, 3000K = 0.96, 3500K = 0.98, 5000K = 1.02. All values nominal. See page 3 for photometry.

<sup>3</sup>See page 2 for actual fixture lengths.



### Individual Fixtures & Continuous Rows

NOMINAL LENGTH	ACTUAL LENGTH
4'	3' 11"
8'	7' 5-5/32"
12'	11' 4-5/32"
16'	14' 10-5/16"
20'	18' 9-5/16"
24'	22' 3-15/32"

Individual fixtures and rows are continuously illuminated and joined with included aligner brackets and hardware.

Individual fixtures up to 8' nominal and continuous rows up to 24' nominal are dimensioned as shown below. Continuous rows longer than 8' and patterns, including EPC/EMC and sensor locations must be approved prior to manufacturing.

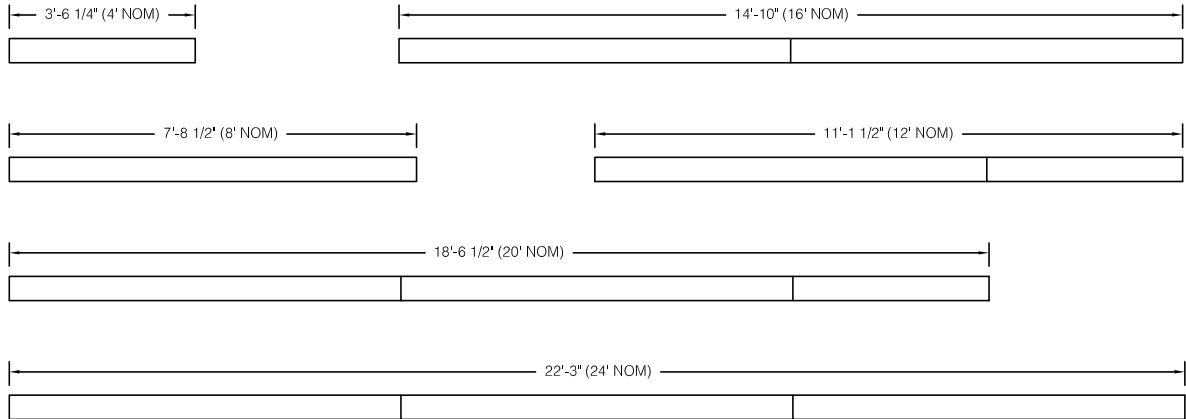

### Emergency & Sensor Locations

EPC will control entire length of individual fixtures. Individual fixtures of differing lengths will deliver the same lumens under EPC power (a 4' fixture will deliver the same total lumens over half the length of an 8' fixture). EMC controlled individual fixtures will deliver lumens per foot as originally specified, unless dimmed at time of power loss. Consult factory for EMC dimming override device.

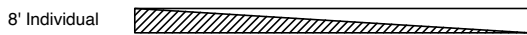

For individual fixtures to 8' EPC/EMC will power entire fixture.

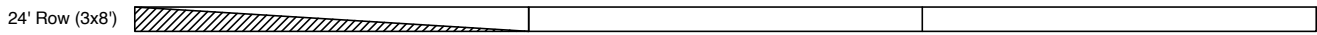

For continuous rows longer than 8' one EPC/EMC will be located in the feed section (end-left) of the row as shown below.

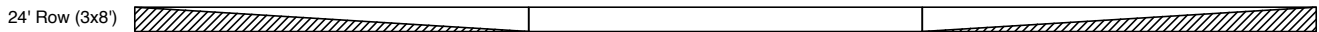

If two EPC/EMC's are required their default locations will be in the feed section (end-left) and last section (end-right) as below.



Custom placement of one or more EPC/EMC's must be clearly identified during ordering.



SENSORS (Integral) for individual fixtures will control entire length of fixture and will be located on feed end of fixture.

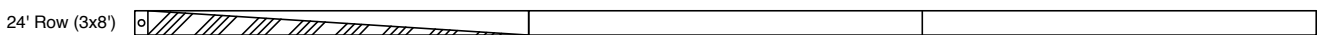

SENSORS for rows by default will control the feed section (end-left) of the row. Sensors can control more than an 8' section within a row. Consult factory for sensor/section options, or for multiple sensors in a continuous row.

## Photometry

GEML-1919-D-SI-40-LO-4

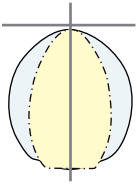

4000K CCT  
WATTS: 21  
LUMENS: 1775  
LPW = 86  
Distribution:  
100% Direct

GEML-1919-D-SI-40-SO-4

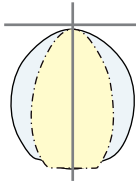

4000K CCT  
WATTS: 28  
LUMENS: 2366  
LPW = 86  
Distribution:  
100% Direct

## Specifications

**HOUSING:** Die-formed, 20-gauge, cold rolled steel riveted construction.

**REFLECTOR:** Reflector assembly is die-formed 20-gauge, cold rolled steel finished in baked white enamel.

**OPTICS:** Satin Ice acrylic is standard. Shatter resistant polycarbonate is also available.

**LEDS:** LED modules in 30/35/40 & 50K CCT, 80+ CRI (90 CRI available). Lumen maintenance minimum  $L_{70} = 50,000$  hours @ 25 C° ambient temperature. 3 SDCM color consistency. Zhaga™ compliant (Book 7).

**DRIVER** Standard driver is Class 2 AOC 0-10V to 1%, 120/277V input, PF > 90%, THD < 20 @ 120V. Additional dimming protocols available. All drivers prewired from factory for connection to control system (by others). Field replaceable.

**MOUNTING:** Standard installation is for dry wall ceiling. Mounting brackets are provided with each fixture. **FINISH:** Fixture housing and steel components are finished in baked white enamel applied over a five-stage pretreatment process.

**CERTIFICATION:** Luminaires are cETLus listed conforming to UL STD. 1598 and certified to CSA STD C22.2 NO. 250.0. Suitable for dry locations; consult factory for damp locations. Union Made in the United States of America. I.B.E.W. RoHS compliant.

Day-O-Lite offers a variety of tunable white and tunable color options for a range of human centric applications and budgets. It is recommended that a recognized authority on the benefits and best practices of tunable white be consulted prior to specification. As a rule, fewer channels will provide a basic level of performance for budget conscious applications. Conversely, an increased number of channels, a wider CCT range, higher CRI and more precise color consistency may be more appropriate depending on the application and desired results.

**HOW TO SPECIFY**

Select from the various channel/control options below and insert desired **Ordering Code** into the **COLOR TEMP** column of the Ordering Guide on page 1. No need to add a dimming option as the codes include the chosen protocol.

**2-CHANNEL TUNABLE WHITE OPTIONS**

2700K - 6500K CCT range  
 1000L/ft LED modules @ 4000K  
 80+ CRI w/3SDCM color accuracy  
 10W/ft. nominal power

**Ordering Codes**

**2DIM10** for 0-10V control  
**2DALI** for DALI control  
**2DMX** for DMX control  
**2PSQ** for Lutron Quantum control  
**2SNS** for control via Signify SNS sensors  
**2CAS** for control via Casambi BLE wireless devices

**LEGRAND BLANCO MULTI-CHANNEL OPTIONS**

**Blanco-2**

Blanco-2 mixes two channels of white LEDs to approximate the blackbody curve for tunable white applications. CCT and intensity may be adjusted with controls by others.

3000K-5000K CCT range  
 1000L/ft LED modules @ 4000K  
 90+ CRI w/2SDCM color accuracy  
 10W/ft. nominal power

**Ordering Codes**

**B2DLM** for DLM control

**Blanco-3**

Blanco-3 mixes three channels of white LEDs across a wider range of color temperatures for more demanding tunable white applications. CCT and intensity may be adjusted with controls by others.

2700K-6500K CCT range  
 1000L/ft. LED modules @ 4000K  
 90+ CRI w/SDCM color accuracy  
 10W/ft. nominal power

**Ordering Codes**

**B3DLM** for DLM control

**RGB & RGBW TUNABLE COLOR**

RGB = Red, Green, Blue color mixing LEDs  
 RGB/W = Red, Green, Blue + White of chosen CCT  
 Dimming from 100% to 1%.  
 90+ CRI w/3SDCM color accuracy  
 10W/ft. nominal power

**Notes:**

RGB requires an RGB DMX or DALI controller (by others)

RGBW requires an RGBW DMX or DALI controller (by others)

All channels on one driver is standard, if isolating the White from the RGB channels is desired please consult factory.

RGB and RGBW are not recommended for tunable white applications.

**Ordering Codes**

**RGB** for DMX control  
**RGB27** for DMX control w/2700K white  
**RGB30** for DMX control w/3000K white  
**RGB35** for DMX control w/3500K white  
**RGB40** for DMX control w/4000K white  
**RGB50** for DMX control w/5000K white  
**RGB65** for DMX control w/6500K white  
 Add Suffix **DAL** for DALI Control to codes above.

**5-CHANNEL TUNABLE WHITE AND COLOR**

RGBWW = Red, Green, Blue, Warm White, Cool White.  
 Consult factory for RGBWW tunable white/color options.

Day-O-Lite makes no claims as to the psychological or physiological efficacy of the white color tuning options offered herein.