



New Age Series | NASL-2045 2x2

Date	Notes
Project	
Type Qty	

Features

- "Zero Plenum" design to fit within grid T-Bars.
- LED optimized optics for smooth, efficient illumination.
- Programmable driver for custom lumen packages.
- 0-10V dimming to 1% standard or Dim-to-Off.
- DMX, Lutron and DALI protocols also available.
- Sensor Ready for wireless Smart Lighting Solutions.
- 80/90CRI, Tunable White, RGBW & RGBWW.
- Bios SkyBlue™ circadian solutions available.
- Compatible with Armstrong® ceiling systems.

Declare Red List Approved.

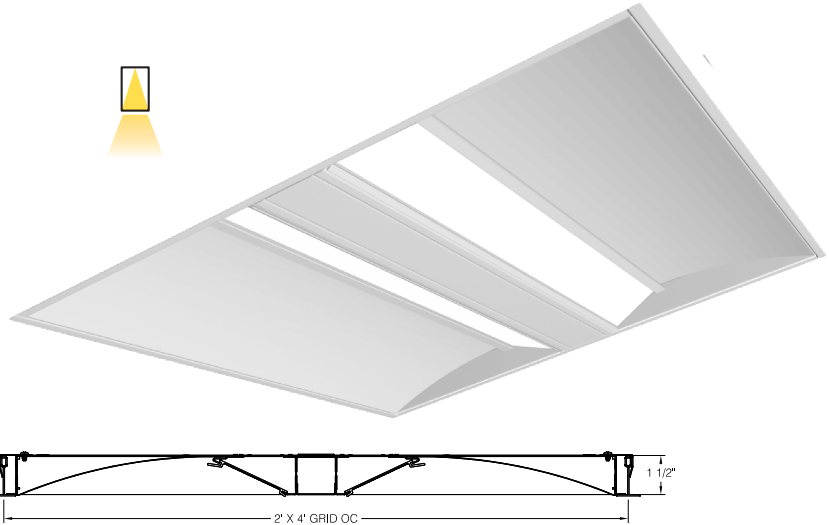

Ordering Guide



MODEL	OPTICS	CCT ¹	LUMENS ²	SIZE	MOUNTING ³	FINISH	OPTIONS
NASL-2045-D	ARL			22			
NASL-2045-D Direct	ARL = Acrylic Ribbed Lens (Frosted)	STATIC WHITE 27 = 2700K 30 = 3000K 35 = 3500K 40 = 4000K 50 = 5000K BIOS SkyBlue Spectrally optimized circadian solutions. TUNABLE WHITE (2700K-6500K) 2DIM10 = for 0-10V 2DMX = for DMX 2ESN = for Philips 2CAS = for Casambi 2LUT = for Lutron DIM-TO-WARM DTW = Dim-to-Warm RGB & WHITE RGB = RGB RGBW = RGBW RGBWW = RGBWW (2700K-6500K)	STANDARD LO = 2700 (20W, 135LPW) SO = 3600 (27W, 133LPW) HO = 4500 (35W, 120LPW) CUSTOM Specify value < HO.	22 = 2x2	G = Grid 15/16" T-Bar MG = Mini Grid 9/16" T-Bar SG = Slot Grid SGF = Slot Grid Flush XG = Interlude XGF = Interlude Flush TGF = Tegular Flush 15/16" T-Bar XGF = Tegular Flush 9/16" T-Bar S = Surface F = Flange	W = White CC = Custom Color AMW = Anti-Microbial White	DIMMING DRIVERS DIM10 = 0-10V (1%) Standard DTO = 0-10V (Dim-to-Off) DIMST = 0-10V Step Dimming DIMSR = DALI Sensor Ready (5.0%) DALI = DALI (5.0%) DMX = DMX LUTRON™ DIMMING DRIVERS LDE1 = Hi-Lume 1% EcoSystem LD2 = Digital 1% (DALI-2) L3DA3W = Hi-Lume 1% 3-Wire SENSORS & CONTROLS⁴ AVO = Avi-On Sensor AWNS = Lutron Athena Sensor ESN = EasySense Sensor CAS = Casambi Wireless Control EMERGENCY & OTHER⁵ EMC = Emergency Circuit GTD = Generator Transfer Device EPC4 = 4W Emergency Battery Pack EPC6 = 6.5W Emergency Battery Pack EPC10 = 10W Emergency Battery Pack EPC12 = 12W Emergency Battery Pack WIRING & OTHER FWH = Flexible Wiring Harness DWH = DMX Wiring Harness FK14 = Flange Kit

¹All LED, BIOS, Tunable White, DTW, and RGB/W options and Ordering Codes page 2.

²Lumens at 80CRI, 4000K, ARL lens. Photometry page 3.

³See page 3 for all mounting options.

⁴All Sensor & Control options page 2. Sensors remote mount only.

⁵EPC6 is standard unless otherwise specified. EPC not for DMX drivers.

BAA letter of compliance available at www.dayolite.com.

LED, BIOS, Sensor & Control Ordering Codes**LED****Static White**

30 = 3000K 80 CRI
 35 = 3500K 80 CRI
 40 = 4000K 80 CRI
 50 = 5000K 80 CRI

927 = 2700K 90 CRI
 930 = 3000K 90 CRI
 935 = 3500K 90 CRI
 940 = 4000K 90 CRI

Tunable White¹
(2700K-6500K)

2DIM10 = 0-10V 80 CRI
 2DMX = DMX 80 CRI
 2CAS = Casambi Wireless 80 CRI
 2ESN = Philips EasySense 80 CRI
 2LUT = Lutron (LD2) 80 CRI

92DIM10 = 0-10V 90 CRI
 92DMX = DMX 90 CRI
 92CAS = Casambi Wireless 90 CRI
 92ESN = Philips EasySense 90 CRI
 92LUT = Lutron (LD2) 90 CRI

Dim-to-Warm²

DTW = 6500K-2700K 80 CRI
 9DTW = 6500K-2700K 90 CRI

RGB/W³

RGB = RGB only
 RGB27 = RGB w/2700K
 RGB30 = RGB w/3000K
 RGB35 = RGB W/3500K
 RGB40 = RGB w/4000K
 RGB50 = RGB w/5000K
 RGBWW = RGB w/2700K-6500K

Single Color

RED = Red
 BLU = Blue
 GRN = Green
 AMB = Amber

BIOS SkyBlue

BIOS SkyBlue biological technology brings the benefits of blue skies inside. BIOS SkyBlue is the only spectrally optimized circadian solution to target the region that drives wellness benefits including: increased alertness, enhanced productivity, better mood, and better sleep. More information may be found at www.bioslighting.com or by contacting Day-O-Lite directly. All options for 0-10V control.

BIOS Biological Static

For daytime applications. BIOS Static Biological LED features key BIOS SkyBlue (490nm) for maximum daytime circadian impact.

B30 = 3000K
 B35 = 3500K
 B40 = 4000K

BIOS Biological Dynamic White

Designed to transition from daytime to evening in a dim-to-warm protocol. The daytime CCT includes full BIOS SkyBlue (490nm) for maximum daytime circadian impact, while the evening spectrum removes BIOS SkyBlue for minimal circadian stimulus after hours.

B30D = 3000K-2700K
 B35D = 3500K-3000K
 B40D = 4000K-3500K

BIOS Biological Tunable White

Designed to transition from daytime to evening in a tunable white protocol. The daytime CCT includes full BIOS SkyBlue (490nm) for maximum daytime circadian impact, while the evening spectrum removes BIOS SkyBlue for minimal circadian stimulus after hours.

B30T = 3000K-2700K
 B35T = 3500K-2700K
 B40T = 4000K-2700K

Sensors & Controls**Sensors***

AVO = Avi-On Occ/Day
 AVM = Avi-On Occ (Microwave)
 BNV = BubblyNet Occ/Day
 ENC = Encelium Occ/Day
 ENL = EnLighted Occ/Day/Temp
 LEG = Legrand Occ/Day
 ANW = Lutron Athena Occ/Day
 VIVE = Lutron Vive Occ/Day
 NLT = Acuity nLight Occ/Day
 NXC = Current NX Occ/Day
 ESN = Philips EasySense Occ/Day
 WVW = Cooper WaveLinX Occ/Day

Wireless Control*

CAS = Casambi

*Sensors for remote mount only.

Sensors and control options to be commissioned wirelessly in the field by qualified controls personnel with applicable apps (by others).

Other Options

Other sensor and wireless control options are available. Contact factory for details.

¹Tunable white may be controlled by a number of dimming protocols as shown.

²Dim-to-Warm mimics incandescent dimming by warming the CCT from 6500K to 2700K as light levels are dimmed.

³All RGB, RGBW and RGBWW options for DMX control (by others). 80 CRI standard.

Grid Ceiling Mounting Options

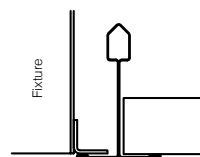

G
15/16" T-Bar

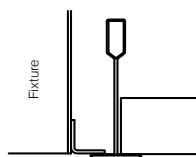

MG
9/16" T-Bar

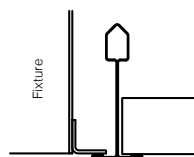

SG
Slot Grid

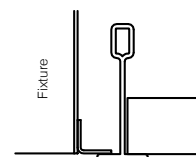

XG
Interlude

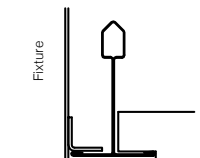

TGF
15/16" Tegular
Flush

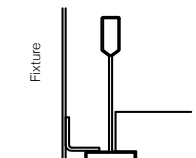

MTGF
9/16" Tegular
Flush

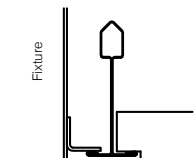

SGF
Slot Grid
Flush

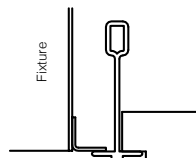

XGF
Interlude
Flush

Additional Mounting Options

In addition to recessed mounting in grid ceilings Harmony may also be installed in plaster and sheetrock ceilings, surface mounted to ceilings, or suspended. Surface and suspended options are supplied with a finished exterior housing.

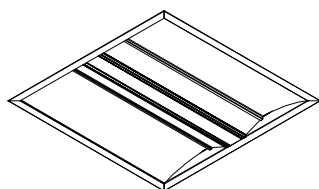

F
Flanged Housing
(plaster ceilings)

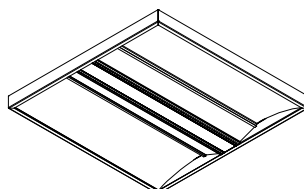

S
Surface Ceiling mount
w/finished housing

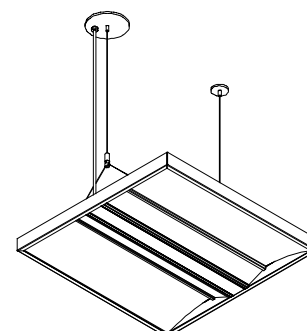

ACY
Suspended Aircraft
Cable (1/16" dia., 48"L)

FK-22 Flange Kit available for grid to plaster ceiling conversion

Photometry

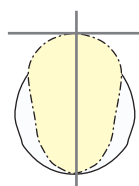

NASL-2045-D-ARL-40-**LO**-22
CCT: 4000K
WATTS: 20
LUMENS: 2700
LPW: 135

NASL-2045-D-ARL-40-**SO**-22
CCT: 4000K
WATTS: 27
LUMENS: 3600
LPW: 133

NASL-2045-D-ARL-40-**SO**-22
CCT: 4000K
WATTS: 35
LUMENS: 4500
LPW: 129

4000K @ 80CRI, ARL lens.

Use the following multipliers for other CCTs: 2700K x 0.94, 3000K x 0.96, 3500K x 0.98, 5000K x 1.02. IES files @ www.dayolite.com

Specifications

CONSTRUCTION: 20 gauge CRS housing and internal components.

REFLECTOR: 20 gauge CRS finished in highly reflective baked white enamel with pre-finished reflective LED tray.

OPTICS: LED optimized acrylic ribbed snap-in lenses (ARL).

LED: Static white LED modules in 27/30/35/40 & 50K CCT, 80/90CRI. Lumen maintenance minimum $L_{70}=50,000$ hours. 3 SDCM color consistency. BIOS SkyBlue, RGB, RGBW, RGBWW. Tunable White and Dim-to-Warm options available.

DRIVER: Driver is Class 2 AOC 0-10V to 1%, Dim-to-Off available. 120/277V input, PF > 90%, THD < 20 @ 120V. Additional dimming protocols available. All drivers prewired from factory for connection to control system (by others). Field replaceable.

MOUNTING: Standard installation is in an exposed inverted T-bar ceiling. Fixtures are supplied with four support brackets for additional support to T-bar. May also be installed in a plaster ceiling (F/TRL mounting option with Flange); field replaceable.

FINISH: Housing and components finished in baked white enamel.

CERTIFICATION: cETLus listed conforming to UL STD. 1598 and certified to CSA STD C22.2 NO. 250.0. Suitable for dry & damp locations. Union Made in the United States of America, I.B.E.W, BAA compliant, Declare Red List Approved.

LEGAL: Day-O-Lite, a division of SCW Corporation. All rights reserved. The Day-O-Lite logo is a registered trademark of SCW Corporation. Day-O-Lite reserves the right to change specifications without notice for product improvement.