

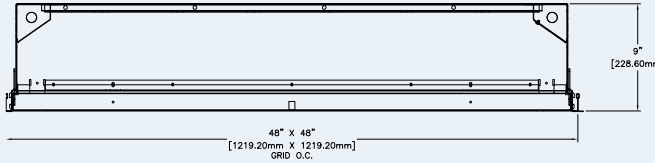

New Age Series | NASL-RND-D-4

Date	Notes
Project	
Type	Qty



Grid Ceiling Flat Lens.
See page 2 for all lens and ceiling options.



Features

- Steel housing with flat, convex or concave lens options.
- LED optimized optics for smooth even illumination without glare.
- Installation in a wide variety of suspended grid and plaster/drywall ceilings.
- High efficiency driver for custom lumen packages. 0-10V dimming to 1% standard.
- High efficacy LEDs in 80 or 90 CRI; two or three channel tunable white; tunable color.

Ordering Guide

MODEL	OPTICS	CCT ¹	LUMENS ²	DIAMETER	MOUNTING ³	FINISH	OPTIONS
NASL-RND-D				4			
NASL-RND-D Direct	SI = Satin Ice Acrylic (Flat) CX = Convex (white opal acrylic) CC = Concave (white opal acrylic)	27 = 2700K 80CRI 30 = 3000K 80CRI 35 = 3500K 80CRI 40 = 4000K 80CRI 50 = 5000K 80CRI 90 CRI add *9* Ex: 940 = 4000K @ 90 CRI	GRID CEILINGS LO = 5850 (63W, 93LPW) SO = 7800 (84W, 93LPW) HO = 9800 (105W, 90LPW) DRYWALL CEILINGS (Flange, Trimless) LO = 7875 (84W, 93LPW) SO = 10,500 (112W, 93LPW) HO = 13,000 (140W, 90LPW) Consult factory for additional lumen packages. All values nominal.	4 = 4'	G = Grid MG = Mini Grid SG = Slot Grid F = Flanged See all mounting options page 2.	W = White CC = Custom Color AMW = Anti-Microbial White	DIMMING DRIVERS DIM10 = 0-10V (1.0%) - Standard DIMSR = 0-10V (5.0%) Sensor Ready DIMST = Step Dimming (40%/100%) DALI = DALI (5.0%) LUTRON™ DIMMING DRIVERS LDE1 = Hi-Lume™ 1% EcoSystem™ LDE5 = 5-Series 5% EcoSystem™ L3DA3W = Hi-Lume™ 1% 3-Wire LTEA2W = Hi-Lume 1% 2-Wire 120V SENSORS & CONTROLS ESN = Philips EasySense DAY = Daylight Harvesting OCC = Occupancy Sensor CAS = Casambi Bluetooth control VDO = Vive Sensor by Lutron EMERGENCY EMC = Emergency Circuit GTD = Generator Transfer Device EPC4 = 4W Emergency Battery Pack EPC7 = 7W Emergency Battery Pack EPC10 = 10W Emergency Battery Pack EPC12 = 12W Emergency Battery Pack
	TUNABLE WHITE & COLOR¹ <u>2-Channel White</u> 2DIM10 = for 0-10V 2DALI = for DALI 2DMX = for DMX 2PSQ = for Lutron 2SNS = for Signify 2CAS = for Casambi <u>3-Channel White</u> 3DLM = for DLM <u>3-Channel Color</u> RGB <u>4-Channel Color/White</u> RGBW <u>5-Channel Color/Warm White/Cool White</u> RGBWW						

¹Tunable white, tunable color options detailed on page 5.

²Delivered lumens at 80+CRI 4000K CCT. Use the following multiplier to estimate delivered lumens at other CCTs: 2700K = 0.94, 3000K = 0.96, 3500K = 0.98, 5000K = 1.02. All values nominal.

³See page 2 for ceiling mounting options. Page 4 for full specifications.



Mounting Options

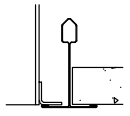

15/16" T-Bar (G)

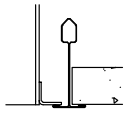

9/16" T-Bar (MG)

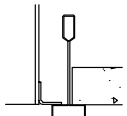

Slot Grid (SG)

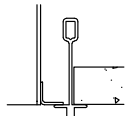

Interlude (XG)

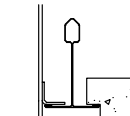

15/16" Tegular Flush (TGF)

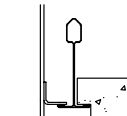

9/16" Tegular Flush (MTGF)

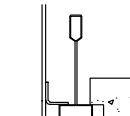

Slot Grid Flush (SGF)

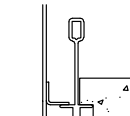

Interlude Flush (XGF)

Housing and Lens Details

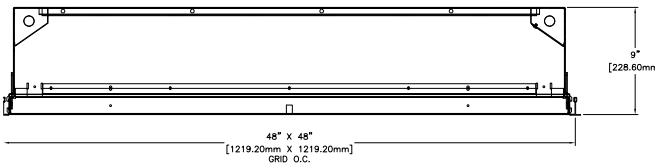

Grid Ceiling Flat Lens

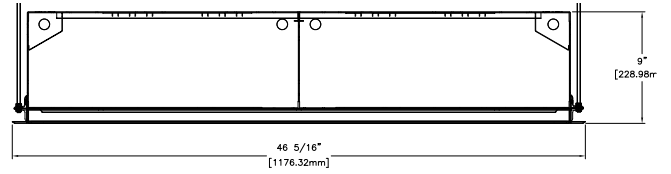

Drywall Ceiling Flat Lens

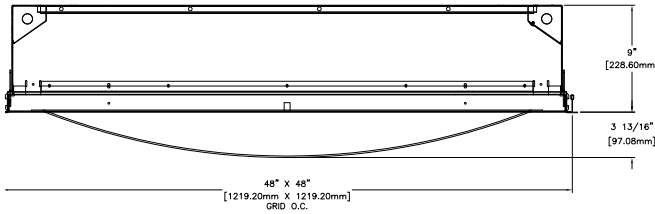

Grid Ceiling Convex Lens

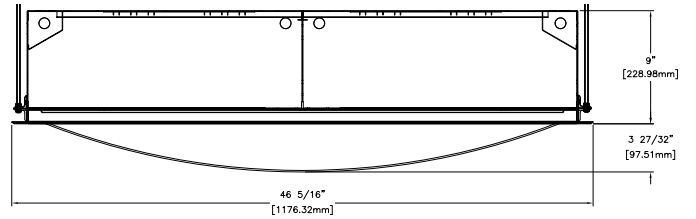

Drywall Ceiling Convex Lens

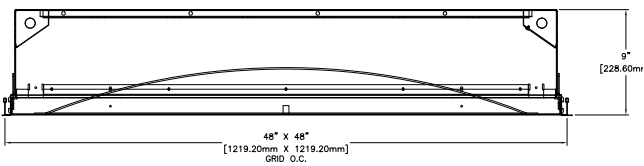

Grid Ceiling Concave Lens

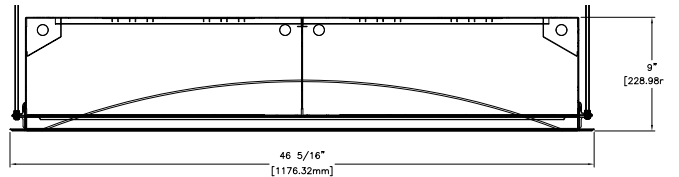

Drywall Ceiling Concave Lens

Grid Ceiling

Five-step universal Installation sequence.

Complete installation instructions for grid and drywall ceiling types are available at: www.dayolite.com

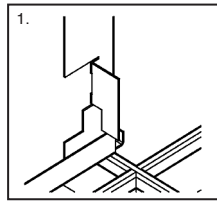

Position Fixture

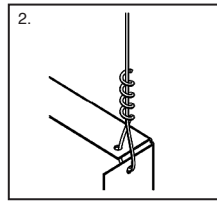

Secure Tie Wire

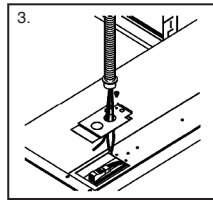

Connect Power

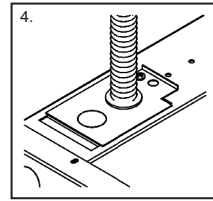

Close Access Plate

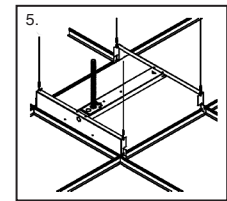

Installation Complete

Drywall/Plaster Ceiling

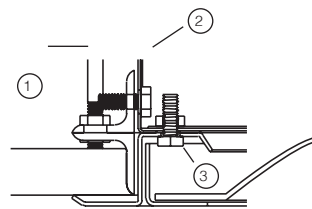
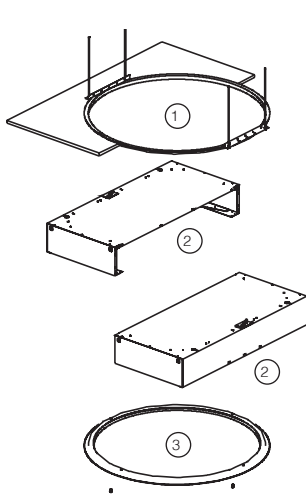

Flange Detail

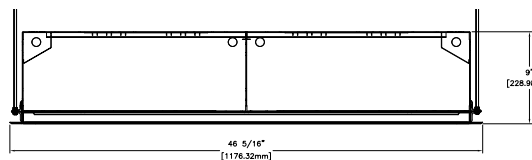

- ① Secure plaster frame to the ceiling with rods or wire ties. The plaster frames are ship prior to the fixture for ceiling preparation.
- ② Insert the fixture sections one at a time. The fixture housing is fabricated in two mating sections to allow entry through the plaster frame aperture, the housing is furnished with the necessary hardware for field attachment.
- ③ Install the lens frame assembly to the fixture housing. The lens frame is provided with hardware and is tethered to allow access inside the fixture. The lens door is secured with a bayonet twist locking action.

Photometry

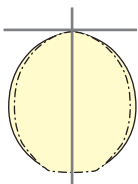

FOR ALL GRID CEILINGS

NASL-RND-D-SI-40-**LO**-4-G

CCT: 4000K
WATTS: 63
LUMENS: 5850
LPW: 93 LPW
Distribution:
100% Direct

NASL-RND-D-SI-40-**SO**-4-G

CCT: 4000K
WATTS: 84
LUMENS: 7800
LPW: 93 LPW
Distribution:
100% Direct

FOR DRYWALL CEILINGS

NASL-RND-D-SI-40-**LO**-4-F

CCT: 4000K
WATTS: 84
LUMENS: 7875
LPW: 93 LPW
Distribution:
100% Direct

Specifications

CONSTRUCTION: 20 gauge CRS housing and internal components.

REFLECTOR: 20 gauge CRS finished in highly reflective baked white enamel with pre-finished reflective LED tray.

OPTICS: LED optimized Satin Ice (SI) acrylic lay-in lens and convex (CX) or concave (CC) white opal acrylic lens.

LED: LED modules in 30/35/40 & 50K CCT, 80 CRI (90CRI available). L_{70} = 50,000 hours. 3 SDCM color consistency; field replaceable.

DRIVER Standard driver is Class 2 AOC 0-10V to 1%, 120/277V input, PF > 90%, THD < 20 @ 120V. Additional dimming protocols available. All drivers prewired from factory for connection to control system (by others); field replaceable.

MOUNTING: Standard installation is in an exposed inverted T-bar ceiling. Fixtures are supplied with four support brackets for additional support to T-bar. May also be installed in a plaster ceiling (F/TRL mounting option with Flange).

FINISH: Housing and components finished in baked white enamel.

CERTIFICATION: Luminaires are cETLus listed conforming to UL STD. 1598 and certified to CSA STD C22.2 NO. 250.0. Suitable for dry & damp locations. Union Made in the United States of America. I.B.E.W. RoHS compliant.

Day-O-Lite offers a variety of tunable white and tunable color options for a range of human centric applications and budgets. It is recommended that a recognized authority on the benefits and best practices of tunable white be consulted prior to specification. As a rule, fewer channels will provide a basic level of performance for budget conscious applications. Conversely, an increased number of channels, a wider CCT range, higher CRI and more precise color consistency may be more appropriate depending on the application and desired results.

HOW TO SPECIFY

Select from the various channel/control options below and insert desired **Ordering Code** into the **COLOR TEMP** column of the Ordering Guide on page 1. No need to add a dimming option as the codes include the chosen protocol.

2-CHANNEL TUNABLE WHITE OPTIONS

2700K - 6500K CCT range
 1000L/ft LED modules @ 4000K
 80+ CRI w/3SDCM color accuracy
 10W/ft. nominal power

Ordering Codes

2DIM10 for 0-10V control
2DALI for DALI control
2DMX for DMX control
2PSQ for Lutron Quantum control
2SNS for control via Signify SNS sensors
2CAS for control via Casambi BLE wireless devices

LEGRAND BLANCO MULTI-CHANNEL OPTIONS

Blanco-2

Blanco-2 mixes two channels of white LEDs to approximate the blackbody curve for tunable white applications. CCT and intensity may be adjusted with controls by others.

3000K-5000K CCT range
 1000L/ft LED modules @ 4000K
 90+ CRI w/2SDCM color accuracy
 10W/ft. nominal power

Ordering Codes

B2DLM for DLM control

Blanco-3

Blanco-3 mixes three channels of white LEDs across a wider range of color temperatures for more demanding tunable white applications. CCT and intensity may be adjusted with controls by others.

2700K-6500K CCT range
 1000L/ft. LED modules @ 4000K
 90+ CRI w/2SDCM color accuracy
 10W/ft. nominal power

Ordering Codes

B3DLM for DLM control

RGB & RGBW TUNABLE COLOR

RGB = Red, Green, Blue color mixing LEDs
 RGB/W = Red, Green, Blue + White of chosen CCT
 Dimming from 100% to 1%.
 90+ CRI w/3SDCM color accuracy
 10W/ft. nominal power

Notes:

RGB requires an RGB DMX or DALI controller (by others)

RGBW requires an RGBW DMX or DALI controller (by others)

All channels on one driver is standard, if isolating the White from the RGB channels is desired please consult factory.

RGB and RGBW are not recommended for tunable white applications.

Ordering Codes

RGB for DMX control
RGB27 for DMX control w/2700K white
RGB30 for DMX control w/3000K white
RGB35 for DMX control w/3500K white
RGB40 for DMX control w/4000K white
RGB50 for DMX control w/5000K white
RGB65 for DMX control w/6500K white
 Add Suffix **DAL** for DALI Control to codes above.

5-CHANNEL TUNABLE WHITE AND COLOR

RGBWW = Red, Green, Blue, Warm White, Cool White.
 Consult factory for RGBWW tunable white/color options.

Day-O-Lite makes no claims as to the psychological or physiological efficacy of the white color tuning options offered herein.