



ADL-RO6 DI AC INSTRUCTIONS

 RISK OF ELECTRICAL SHOCK. DISCONNECT POWER BEFORE INSTALLATION OR SERVICING.

 TO BE INSTALLED BY A QUALIFIED ELECTRICIAN IN ACCORDANCE TO LOCAL & NATIONAL ELECTRIC CODES.

 FAILURE TO COMPLY TO INSTRUCTIONS & FORMENTIONED WARNINGS COULD VOID PRODUCT WARRANTY

 DO NOT CONSTRUCT ROW ON FLOOR & LIFT TO CEILING.

 CEILING TO BE PROPERLY REINFORCED TO SUPPORT WEIGHT OF THE FIXTURE.

 REFERENCE SHOP DRAWINGS FOR CRITICAL MOUNTING DIMENSIONS.

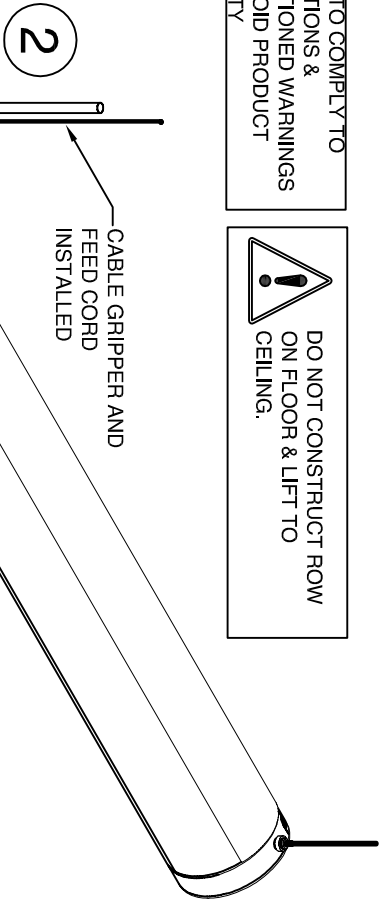
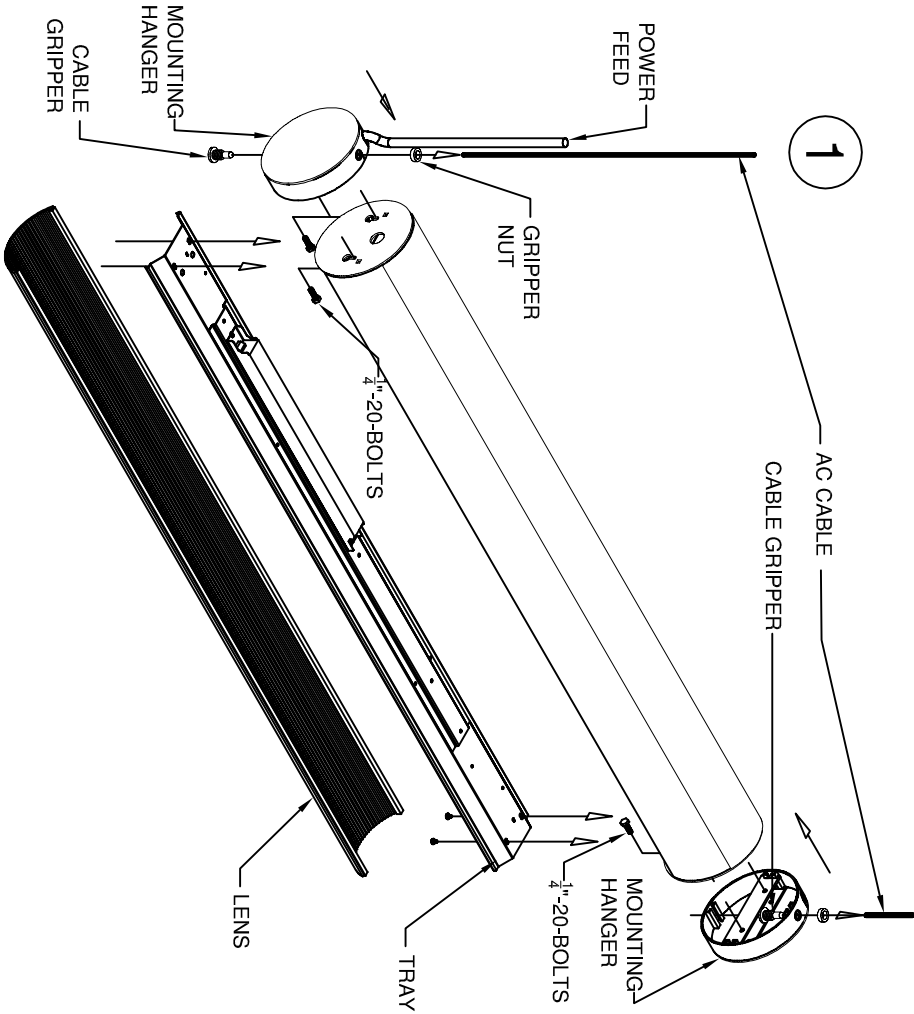

1. REMOVE LENS AND TRAY. INSTALL FEED CORD AND CABLE GRIPPER INTO MOUNTING HANGER. INSTALL MOUNTING HANGER TO HOUSING. HANG FIXTURE. CONNECT AC CABLES TO STRUCTURAL CEILING. CONNECT POWER FEED TO MAINS POWER, TYPICAL WIRING DIAGRAM SHOWN. REFER TO JOB DRAWINGS FOR JOB SPECIFIC WIRING
2. FIXTURE HEIGHT CAN BE ADJUSTED USING THE CABLE GRIPERS. LOOSEN TOP SAFETY CAP OF GRIPPER, ADJUST CABLE LENGTH AND TIGHTEN TOP SAFETY CAP
3. REINSTALL LOWER TRAY
4. REINSTALL LENS

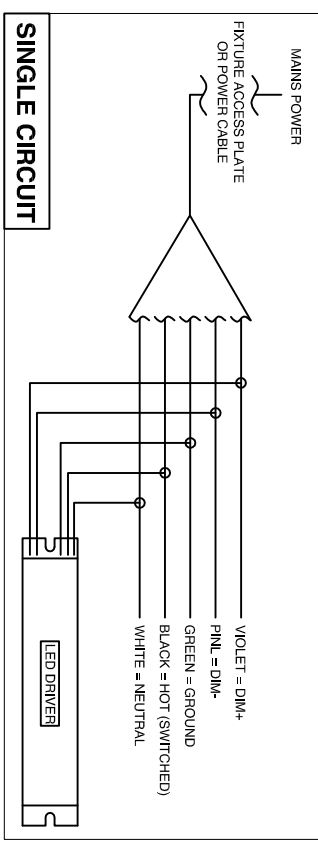

MUST BE INSTALLED BY A QUALIFIED ELECTRICIAN. DISCONNECT POWER DURING INSTALLATION/SERVICING. ROW CONFIGURATION IS JOB SPECIFIC. CONSULT SHOP DRAWINGS BEFORE CONSTRUCTING ROWS. STANDARD OPTIONS/SIZES SHOWN. OTHER OPTIONS AVAILABLE WITH SIMILAIR INSTALLATION. BE SURE TO UNDERSTAND ALL PROCEDURES PRIOR TO INSTALLATION. IMPORTANT: THE NATIONAL ELECTRIC CODE REQUIRES THAT ANY FIXTURE IN EXCESS OF 50 POUNDS MUST BE INDEPENDENTLY SUPPORTED OF THE OUTLET BOX. DAY-O-LITE IS NOT RESPONSIBLE FOR INADEQUATE REINFORCEMENT OF STRUCTURAL SUPPORT SYSTEMS. DAY-O-LITE RESERVES THE RIGHT TO MAKE ANY MECHANICAL OR MATERIAL CHANGES TO THE FIXTURES WHICH DO NOT AFFECT THE APPEARANCE OR PERFORMANCE. THIS PRINT IS THE PROPERTY OF DAY-O-LITE AND THE INFORMATION IT CONTAINS MAY NOT BE USED WITHOUT WRITTEN CONSENT OF DAY-O-LITE.

MODEL NO.: ADL-RO6-DI----	PAGE: SHEET 1 OF 1	PART NUMBER: 970178A0
CONTACT INFORMATION: 126 Chestnut Street, Warwick, RI 02888 Tel. (401) 467-8232 / Fax. (401) 941-2960 E-mail: sales@dayville.com WWW: http://www.dayville.com	ISSUED ON: 4/2/24	
 DAY-O-LITE Lighting Without Limits		